

光，想你所想

DEFINE THE LIGHT WHAT YOU WANT

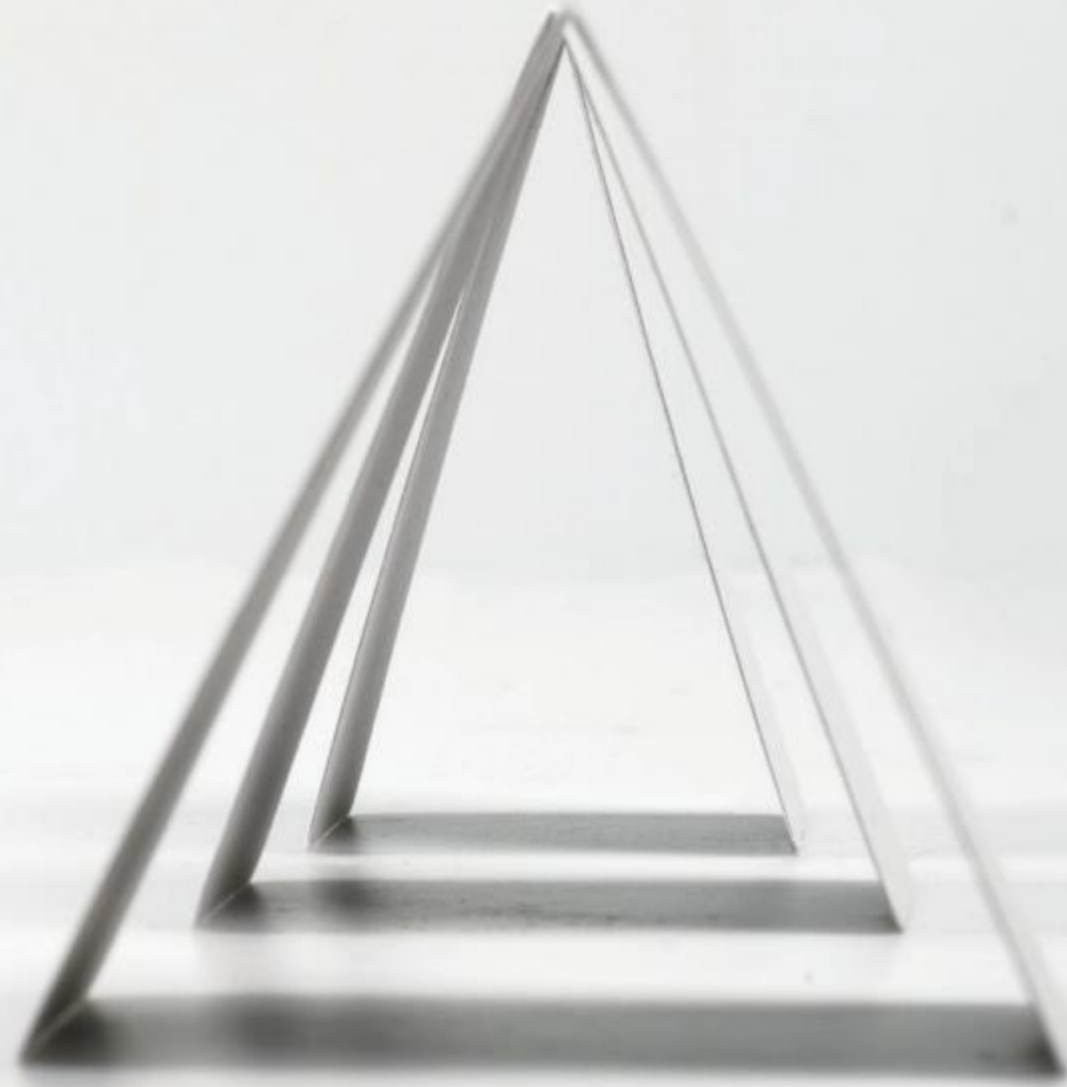

LED Board Tracklight—Ares Series
LED 面板轨道射灯——阿瑞斯系列

025 / 034



KPEBTLAS15W KPEBTLAS15W KPEBTLAS15W KPEBTLAS30W KPEBTLAS30W KPEBTLAS30W

LED Focusing Tracklight—Gaea Series

035 / 040

LED 变焦轨道射灯——盖亚系列



KPEFTLGS25W KPEFTLGS35W

LED Adjustable Downlight—Aurora Series
LED 调节式射灯——欧若拉斯系列

041 / 046



KPEADLAS8W KPEADLAS15W KPEADLAS26W

LED Fixed Downlight—Apollo Series

047 / 052

LED 下照式筒灯——阿波罗系列



KPEFDLAS8W KPEFDLAS15W KPEFDLAS26W

LED Wall Washer—Luna Series
LED 洗墙筒灯——露娜系列

053 / 058



KPEWWS6W KPEWWS15W KPEWWS24W

LED Downlight—Eros Series (Emergency Function)

059 / 064

LED 筒灯——艾罗斯系列 (应急功能)



KPEDLES3W KPEDLES5W KPEDLES9W KPEDLES13W

065 / 072 LED Line Spotlight—Laser Series
LED 线条射灯——雷蛇系列



LED Downlight—Aimer Series
LED 筒灯——埃玛系列 103 / 110



LED Line Wall Washer—Ocean Series
LED 线条洗墙灯——海洋系列 073 / 078



111 / 118 COB Downlight—Goose Series
COB 筒灯——库思系列

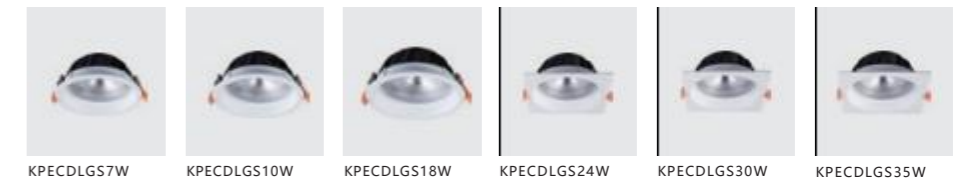

079 / 082 LED Tracklight—Blue Series For Catering
LED 轨道射灯——湛蓝餐饮系列



COB Mounted Downlight—Kaer Series
COB 明装筒灯——卡尔系列 119 / 126



LED Tracklight—Vivid Series For Clothing
LED 轨道射灯——绚彩服装系列 083 / 087



127 / 132 LED Ceiling Light—Rhyme Series
LED 天花射灯——韵系列

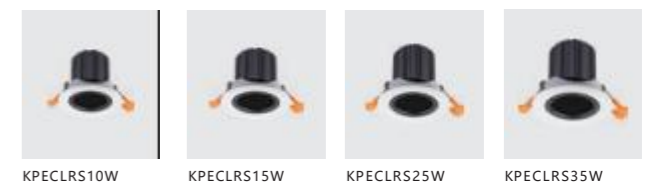

088 / 092 LED Grille Spotlight—Maco Series
LED 格栅射灯——马克系列



LED Dining Light—Mountain Series
LED 餐吊灯——高山系列 133 / 140





























LED Trunk Light—Nature Series
LED 象鼻射灯——自然系列 093 / 102



141 / 146 LED T5 Tube—Square Series / LED Light—Star Series / Track—Track Series
LED T5 灯管——方型系列 / LED 灯带——星辰系列 / 轨道条系列



 下照式 Fixed	 调节式 Adjustable	 洗墙式 Wall washer	 I类灯具 Insulation class1
 II类灯具 Insulation class2	 III类灯具 Insulation class3	 统一眩光值 UGR maximum	 截光角 Cut-off
 可调角度 Horizontal/vertical adjustable beam	 角度不可调 Lockable	 可安装在可燃物表面 Fire-proof mark	 免工具安装 installation without tools
 LED COB 光源 LED COB	 Mr16 光源 Mr16	 恒压 24V DC 24	 刻度标识 Graduations for precision setting
 IP 防护等级 IP rating	 CCC 认证 Certificate mark	 小尺寸灯具 Small luminaire dimensions	 向后散热 Excellent thermal management
 透镜配光 Efficient lens system	 0-10V 调光 0-10V dimmer	 可控硅调光 Triac dimmable	
 室内使用 Indoors	 最小可剪切尺寸 Cutable on site	 最小可弯曲尺寸 Curved Min R50mm	



LED
BOARD TRACKLIGHT
Ares Series

LED Board Tracklight—Ares Series
LED 面板轨道射灯——阿瑞斯系列



KPEBTLAS15W

KPEBTLAS15W

KPEBTLAS15W



KPEBTLAS30W

KPEBTLAS30W

KPEBTLAS30W

Spotlight 射灯：

Narrow beam,emphasis of objects,applied to accentuate artwork,products,furniture and architectural details effectively.Mainly used in Museum,exhibition hall,luxury restaurant and hotel,etc.

极窄光束角，重点照明对象物体，适用于有效照射艺术品、工艺品、家具家私、雕像雕塑。主要应用于博物馆、艺术展览厅、高端餐厅以及星级酒店等等。

Floodlight 泛光射灯：

Wide beam,illumination of conventional objects,applied to light commodities,square picture,shelves,ceramic and commercial shop display.Mainly used in luxury clothing shop,large stores and supermarket,super exhibition hall and other spatial zone,etc.

泛光光束角，主要照明常规物品，适用于照射大宗商品、方形油画、商场货架、陶瓷以及店铺陈列商品。主要应用于高端服装连锁、大型商业店铺、超市、大型展厅以及其他空旷区域等等。

Wallwasher 洗墙射灯：

Vertical illuminance for brightening and dividing the space.Applied to brighten the setting wall,the signboard,the white wall and other indoor empty zones without any shadow area.

偏光洗墙垂直照射，用以照亮或洗亮区域空间，主要适用于无阴影洗亮家居或商业背景墙、广告 LOGO 墙、白墙以及室内空旷的区域墙体等等



Type:Spotlight-KPEBTLAS15W
 Voltage:220-240V/50Hz
 Power:15W
 Color Temperature: 2700K/3000K/4000K/6000K
 Luminous Flux:1400lm
 CRI:Ra>90
 Beam Angle:15°
 Color:White/Black/Grey
 Material:Aluminium
 Size:92*40*148mm
 Adapter:2/3/4-Circuit/Surface Mounted
 Chips:Osram
 Driver:LiFud/PF>0.9
 Life span:30000 hours



灯具类型: 射灯 -KPEBTLAS15W
 电压: 220-240V/50Hz
 功率: 15W
 色温: 2700K/3000K/4000K/6000K
 光通量: 1400lm
 显色指数: Ra>90
 光束角: 15 度
 颜色: 白 / 黑 / 灰
 材质: 压铸铝
 尺寸: 92*40*148mm
 适配器: 2/3/4 线导轨式 / 吸顶式
 光源: 欧司朗
 电源: 莱福德电源 /PF>0.9
 光源寿命: 30000 小时



光学配件 / OPTICAL ACCESSORIES

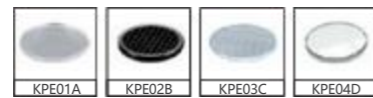

可选 / 不必要 / OPTIONAL / NOT NECESSARY
 KPE01A 柔光镜 soft lens
 KPE02B 蜂窝网 honeycomb
 KPE03C 拉伸镜 striation glass
 KPE04D 清玻片 Clear glass

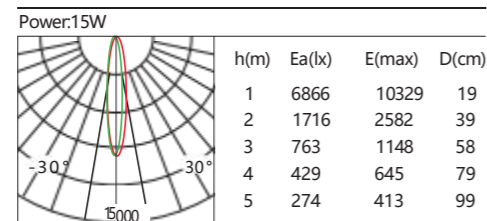

Beam Angle 15° Luminous flux(lm):638 lmax(cd):10329



Type:Floodlight-KPEBTLAS15W
 Voltage:220-240V/50Hz
 Power:15W
 Color Temperature: 2700K/3000K/4000K/6000K
 Luminous Flux:1400lm
 CRI:Ra>90
 Beam Angle:30°
 Color:White/Black/Grey
 Material:Aluminium
 Size:92*40*148mm
 Adapter:2/3/4-Circuit/Surface Mounted
 Chips:Osram
 Driver:LiFud/PF>0.9
 Life span:30000 hours



灯具类型: 泛光射灯 -KPEBTLAS15W
 电压: 220-240V/50Hz
 功率: 15W
 色温: 2700K/3000K/4000K/6000K
 光通量: 1400lm
 显色指数: Ra>90
 光束角: 30 度
 颜色: 白 / 黑 / 灰
 材质: 压铸铝
 尺寸: 92*40*148mm
 适配器: 2/3/4 线导轨式 / 吸顶式
 光源: 欧司朗
 电源: 莱福德电源 /PF>0.9
 光源寿命: 30000 小时



光学配件 / OPTICAL ACCESSORIES



可选 / 不必要 / OPTIONAL / NOT NECESSARY
 KPE01A 柔光镜 soft lens
 KPE02B 蜂窝网 honeycomb
 KPE03C 拉伸镜 striation glass
 KPE04D 清玻片 Clear glass

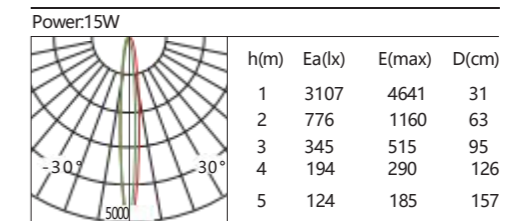

Beam Angle 30° Luminous flux(lm):583 lmax(cd):4643



Type:Wallwasher-KPEBTLAS15W
 Voltage:220-240V/50Hz
 Power:15W
 Color Temperature: 2700K/3000K/4000K/6000K
 Luminous Flux:1400lm
 CRI:Ra>90
 Beam Angle:Wallwash
 Color:White/Black/Grey
 Material:Aluminium
 Size:92*40*148mm
 Adapter:2/3/4-Circuit/Surface Mounted
 Chips:Osram
 Driver:LiFud/PF>0.9
 Life span:30000 hours



灯具类型: 洗墙射灯 -KPEBTLAS15W
 电压: 220-240V/50Hz
 功率: 15W
 色温: 2700K/3000K/4000K/6000K
 光通量: 1400lm
 显色指数: Ra>90
 光束角: 偏光洗墙
 颜色: 白/黑/灰
 材质: 压铸铝
 尺寸: 92*40*148mm
 适配器: 2/3/4 线导轨式/吸顶式
 光源: 欧司朗
 电源: 莱福德电源/PF>0.9
 光源寿命: 30000 小时



光学配件 / OPTICAL ACCESSORIES

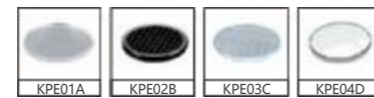

可选 / 不必要 / OPTIONAL / NOT NECESSARY
 KPE01A 柔光镜 soft lens
 KPE02B 蜂窝网 honeycomb
 KPE03C 拉伸镜 striation glass
 KPE04D 清玻片 Clear glass

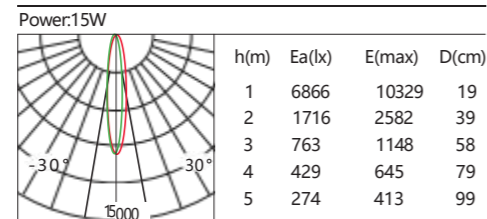

Beam Angle 15° Luminous flux(lm):638 lmax(cd):10329



Type:Spotlight-KPEBTLAS30W
 Voltage:220-240V/50Hz
 Power:30W
 Color Temperature: 2700K/3000K/4000K/6000K
 Luminous Flux:2850lm
 CRI:Ra>90
 Beam Angle:15°
 Color:White/Black/Grey
 Material:Aluminium
 Size:137*47*220mm
 Adapter:2/3/4-Circuit/Surface Mounted
 Chips:Osram
 Driver:LiFud/PF>0.9
 Life span:30000 hours



灯具类型: 射灯 -KPEBTLAS30W
 电压: 220-240V/50Hz
 功率: 30W
 色温: 2700K/3000K/4000K/6000K
 光通量: 2850lm
 显色指数: Ra>90
 光束角: 15 度
 颜色: 白/黑/灰
 材质: 压铸铝
 尺寸: 137*47*220mm
 适配器: 2/3/4 线导轨式/吸顶式
 光源: 欧司朗
 电源: 莱福德电源/PF>0.9
 光源寿命: 30000 小时



光学配件 / OPTICAL ACCESSORIES



可选 / 不必要 / OPTIONAL / NOT NECESSARY
 KPE01A 柔光镜 soft lens
 KPE02B 蜂窝网 honeycomb
 KPE03C 拉伸镜 striation glass
 KPE04D 清玻片 Clear glass

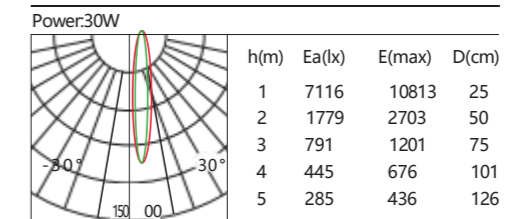

Beam Angle 15° Luminous flux(lm):1274 lmax(cd):10818



Type:Floodlight-KPEBTLAS30W
 Voltage:220-240V/50Hz
 Power:30W
 Color Temperature: 2700K/3000K/4000K/6000K
 Luminous Flux:2850lm
 CRI:Ra>90
 Beam Angle:30°
 Color:White/Black/Grey
 Material:Aluminium
 Size:137*47*220mm
 Adapter:2/3/4-Circuit/Surface Mounted
 Chips:Osram
 Driver:LiFud/PF>0.9
 Life span:30000 hours



灯具类型: 泛光射灯 -KPEBTLAS30W
 电压: 220-240V/50Hz
 功率: 30W
 色温: 2700K/3000K/4000K/6000K
 光通量: 2850lm
 显色指数: Ra>90
 光束角: 30 度
 颜色: 白 / 黑 / 灰
 材质: 压铸铝
 尺寸: 137*47*220mm
 适配器: 2/3/4 线导轨式 / 吸顶式
 光源: 欧司朗
 电源: 莱福德电源 /PF>0.9
 光源寿命: 30000 小时



光学配件 / OPTICAL ACCESSORIES

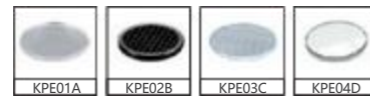

可选 / 不必要 / OPTIONAL / NOT NECESSARY
 KPE01A 柔光镜 soft lens
 KPE02B 蜂窝网 honeycomb
 KPE03C 拉伸镜 striation glass
 KPE04D 清玻片 Clear glass

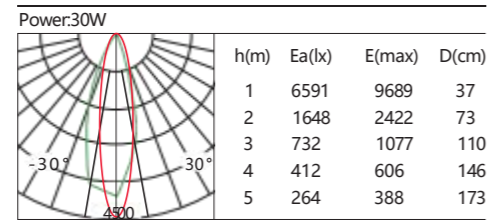

Beam Angle 30° Luminous flux(lm):1573 I_{max}(cd):9689



Type:Wallwasher-KPEBTLAS30W
 Voltage:220-240V/50Hz
 Power:30W
 Color Temperature: 2700K/3000K/4000K/6000K
 Luminous Flux:2850lm
 CRI:Ra>90
 Beam Angle:Wallwash
 Color:White/Black/Grey
 Material:Aluminium
 Size:137*47*220mm
 Adapter:2/3/4-Circuit/Surface Mounted
 Chips:Osram
 Driver:LiFud/PF>0.9
 Life span:30000 hours



灯具类型: 洗墙射灯 -KPEBTLAS30W
 电压: 220-240V/50Hz
 功率: 30W
 色温: 2700K/3000K/4000K/6000K
 光通量: 2850lm
 显色指数: Ra>90
 光束角: 偏光洗墙
 颜色: 白 / 黑 / 灰
 材质: 压铸铝
 尺寸: 137*47*220mm
 适配器: 2/3/4 线导轨式 / 吸顶式
 光源: 欧司朗
 电源: 莱福德电源 /PF>0.9
 光源寿命: 30000 小时



光学配件 / OPTICAL ACCESSORIES



可选 / 不必要 / OPTIONAL / NOT NECESSARY
 KPE01A 柔光镜 soft lens
 KPE02B 蜂窝网 honeycomb
 KPE03C 拉伸镜 striation glass
 KPE04D 清玻片 Clear glass

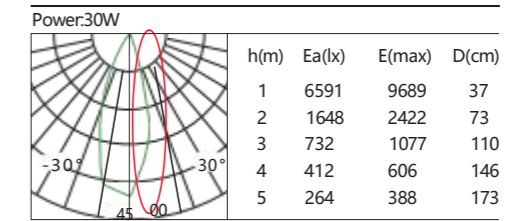

Beam Angle 30° Luminous flux(lm):1573 I_{max}(cd):9689



Luminaire arrangement

Spotlights 射灯
Narrow spot, Spot, Flood

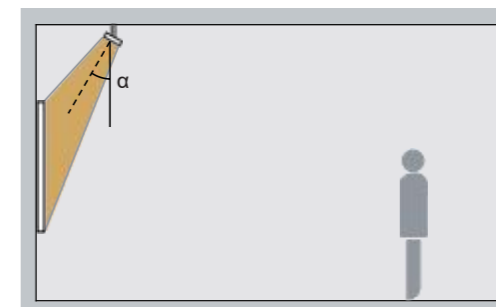

Accentuation
Light Board spotlights accentuate artwork, products and architectural details effectively. The ideal angle of tilt (y) for this is around 30° . The object is modelled without distorting the effect as a result of excessive shadowing. It also prevents shadows cast by the observer.
Arrangement: $y = 30^\circ$

Floodlights 泛光射灯
Wide flood, Extra wide flood, Oval flood

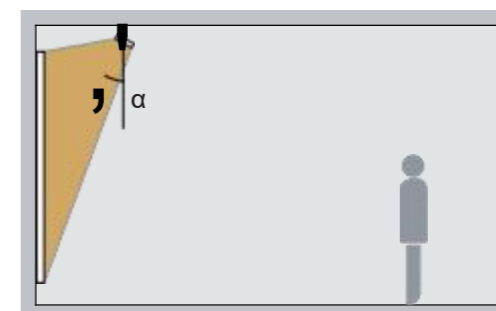

Washlighting
The ideal angle of tilt (y) for floodlighting objects with a long, square shape, e.g. pictures, sculptures or merchandise displays, is around 30° .
Arrangement: $y = 30^\circ$

Lens Washers 洗墙射灯
Wallwash

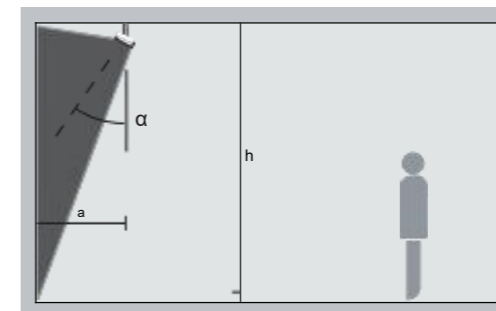

Wallwashing
For uniform vertical illuminance, the distance (a) of Light Board lens washers from the wall should be around one third of the room height (h). This results in an angle of tilt (y) of approx. 35° .
Arrangement: $a = 1/3 \times h$ or $y = 35^\circ$

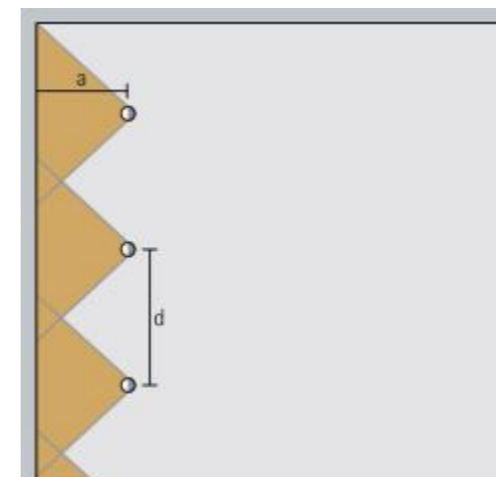

For good longitudinal uniformity, the spacing (d) of Light Board lens washers may be up to 1.2 times the offset from the wall (a).
Arrangement: $d \leq 1.2 \times a$
The optimal wall offset and luminaire spacing for each product are indicated in the wallwasher tables in the catalogue and the product data sheets.



LED FOCUSING TRACKLIGHT Gaea Series

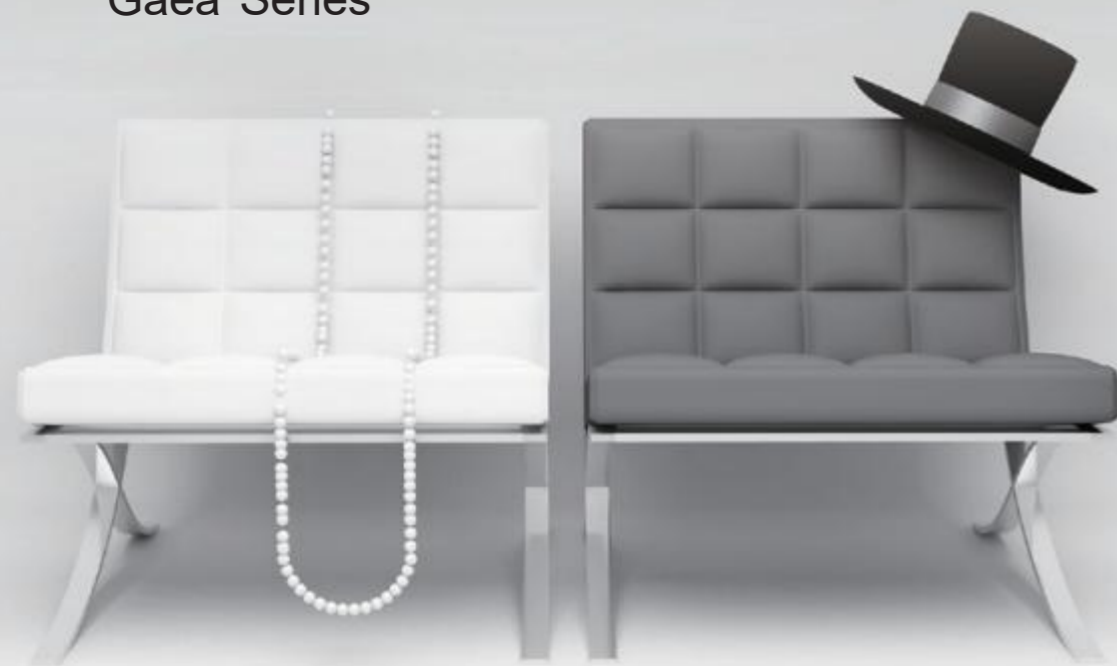

LED Focusing Tracklight—Gaea Series LED 变焦轨道射灯——盖亚系列



KPEFTLGS25W

KPEFTLGS35W

Spotlight 射灯：

Gaea series is the intelligent and elegant light series by K-LUX. It holds the Citizen chips and Philips driver so that why express the excellent performance. High CRI function, large lumen for very high illuminances, 15-45° different light distributions... Besides the normal configuration, Gaea series can be customized in accordance with 2700K-6500K CCT changes, 0-100% dimming range, 15°-45° beam angle choices, full of various personal light demands.

盖亚系列是 K-LUX 公司一款智能精致的匠心灯具。进口西铁城光源加之飞利浦电源使其能展现出卓越的灯具性能，包括高显指、高流明、15-45 度的光束角变换 ... 此系列除了常规配置之外，还可以根据个性化定制 2700K-6500K 的调色温功能，0-100% 范围的调光功能，15-45 度的光束角转换就不用说了，能充分满足各种各样的个性化灯光需求。

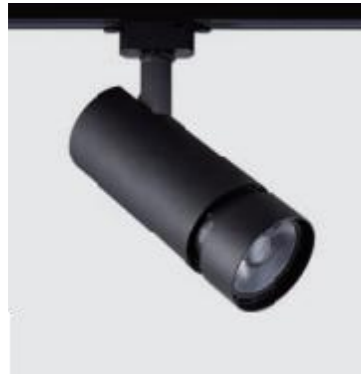

Type:Spotlight-KPEFTLGS25W
 Voltage:220-240V/50Hz
 Power:25W
 Color Temperature: 2700K/3000K/4000K/6000K
 Luminous Flux:2250lm
 CRI:Ra>90
 Beam Angle:15° -45°
 Color:White/Black
 Material:Aluminium
 Size:90*216mm
 Adapter:2/3/4-Circuit/Surface Mounted
 Chips:Citizen
 Driver:Philips/PF>0.9
 Life span:30000 hours

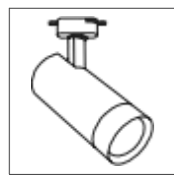

灯具类型: 射灯 -KPEFTLGS25W
 电压: 220-240V/50Hz
 功率: 25W
 色温: 2700K/3000K/4000K/6000K
 光通量: 2250lm
 显色指数: Ra>90
 光束角: 15度 -45度
 颜色: 白 / 黑
 材质: 铝型材
 尺寸: 90*216mm
 适配器: 2/3/4 线导轨式 / 吸顶式
 光源: 西铁城
 电源: 飞利浦电源 /PF>0.9
 光源寿命: 30000 小时



光学配件 / OPTICAL ACCESSORIES

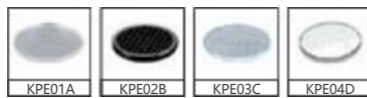

可选 / 不必要 / OPTIONAL / NOT NECESSARY
 KPE01A 柔光镜 soft lens
 KPE02B 蜂窝网 honeycomb
 KPE03C 拉伸镜 striation glass
 KPE04D 清玻片 Clear glass

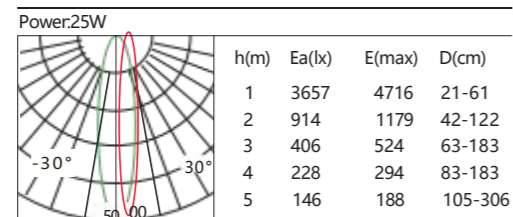

Beam Angle 15°-45° Luminous flux(lm):918 lmax(cd):4716

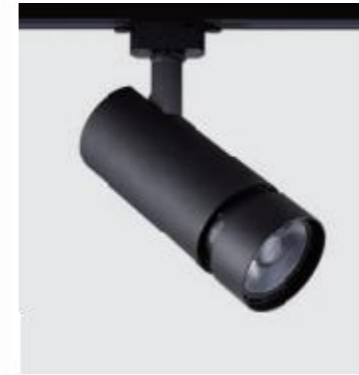

Spotlight-KPEFTLGS35W
 Voltage:220-240V/50Hz
 Power:35W
 Color Temperature: 2700K/3000K/4000K/6000K
 Luminous Flux:3150lm
 CRI:Ra>90
 Beam Angle:15° -45°
 Color:White/Black
 Material:Aluminium
 Size:90*216mm
 Adapter:2/3/4-Circuit/Surface Mounted
 Chips:Citizen
 Driver:Philips/PF>0.9
 Life span:30000 hours



灯具类型: 射灯 -KPEFTLGS35W
 电压: 220-240V/50Hz
 功率: 35W
 色温: 2700K/3000K/4000K/6000K
 光通量: 3150lm
 显色指数: Ra>90
 光束角: 15度 -45度
 颜色: 白 / 黑
 材质: 铝型材
 尺寸: 90*216mm
 适配器: 2/3/4 线导轨式 / 吸顶式
 光源: 西铁城
 电源: 飞利浦电源 /PF>0.9
 光源寿命: 30000 小时



光学配件 / OPTICAL ACCESSORIES



可选 / 不必要 / OPTIONAL / NOT NECESSARY
 KPE01A 柔光镜 soft lens
 KPE02B 蜂窝网 honeycomb
 KPE03C 拉伸镜 striation glass
 KPE04D 清玻片 Clear glass

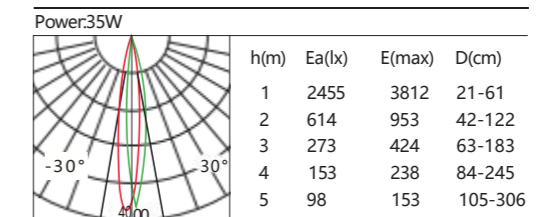

Beam Angle 15°-45° Luminous flux(lm):924 lmax(cd):3819



Luminaire arrangement

Spotlights 射灯
15°

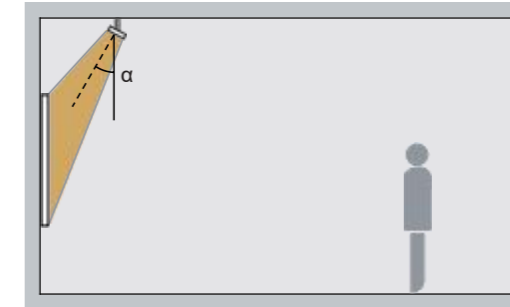

Accentuation
Light Board spotlights accentuate artwork, products and architectural details effectively. The ideal angle of tilt (γ) for this is around 30°. The object is modelled without distorting the effect as a result of excessive shadowing. It also prevents shadows cast by the observer.
Arrangement: $\gamma = 30^\circ$

Floodlights 泛光射灯
36°

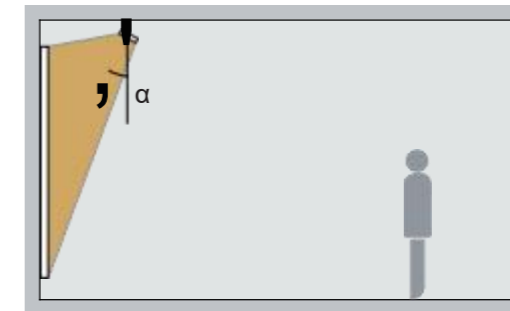

Washlighting
The ideal angle of tilt (γ) for flood-lighting objects with a long, square shape, e.g. pictures, sculptures or merchandise displays, is around 30°.

Arrangement: $\gamma = 30^\circ$

Lens washers 洗墙射灯
60°

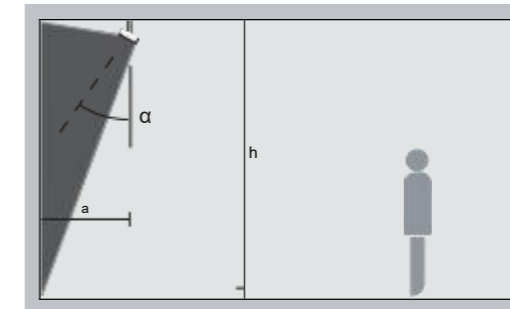

Wallwashing
For uniform vertical illuminance, the distance (a) of Light Board lens washers from the wall should be around one third of the room height (h). This results in an angle of tilt (γ) of approx. 35°.

Arrangement: $a = 1/3 \times h$ or
 $\gamma = 35^\circ$



LED
ADJUSTABLE DOWNLIGHT
Aurora Series

LED Adjustable Downlight—Aurora Series
LED 调节式射灯——欧若拉系列



KPEADLAS8W

KPEADLAS15W

KPEADLAS26W

Spotlight 射灯：

Aurora series adjustable downlight is customized in accordance for upscale star hotel,luxury villa and other commercial space of work,entertainment and leisure.From the lighting effect,lighting replace,space design,installation and application,environment protection ,to optimize the light detail fully.Dimming and non-dimming,3 beam angle,4 optics,6 ring parts,with industrial design,UGR<6,excellent non-glare effect,imported Cree chips with wonderful light and CRI>90,Fud driver providing stable continuity.

欧若拉系列可调式射灯是一款专门为高端星级酒店、高端会所、别墅以及其他工作、娱乐、休闲等高端商业空间量身打造的灯具产品。从灯光效果、灯具替换、空间设计、安装应用、节能环保等多个方面，全方位优化产品细节。可调光与不可调光2种应用方式、3种光束角、4种光学配件、6种面环配件，结合工业设计美学，遮光角大于40°，UGR<6 具有出色的防眩光效果，美国进口科锐芯片呈现极佳的光型光色，莱福德电源提供可靠的续航保证。



Type:Spotlight-KPEADLAS8W
 Voltage:220-240V/50Hz
 Power:8W
 Color Temperature: 2700K/3000K/4000K/5000K
 Luminous Flux:750lm
 CRI:Ra>90
 Beam Angle:15° /24° /36°
 Color:White+Black+Grey
 Material:Aluminium
 Size:70*98mm
 Cutout:55mm
 Chips:Cree
 Driver:LiFud/PF>0.9
 Life span:30000 hours

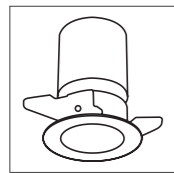

灯具类型: 射灯 -KPEADLAS8W
 电压: 220-240V/50Hz
 功率: 8W
 色温: 2700K/3000K/4000K/5000K
 光通量: 750lm
 显色指数: Ra>90
 光束角: 15度 /24度 /36度
 颜色: 白+黑+灰
 材质: 铝材质
 尺寸: 70*98mm
 开孔: 55mm
 光源: 科锐
 电源: 莱福德电源 /PF>0.9
 光源寿命: 30000 小时



光学配件 / REFLECTING ACCESSORIES



可选必须 / OPTIONAL MUST
 KPE00A 斜口反光下罩真空镀银 Reflector(mirror)
 KPE00B 斜口反光下罩喷漆 - DW White oblique mouth reflective cover
 KPE00C U形孔反光下罩喷漆 - DW/BK U shaped hole reflective cover

光学配件 / OPTICAL ACCESSORIES

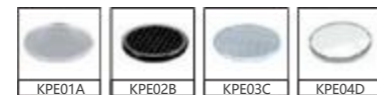

可选 / 不必要 / OPTIONAL / NOT NECESSARY
 KPE01A 柔光镜 soft lens
 KPE02B 蜂窝网 honeycomb
 KPE03C 拉伸镜 striation glass
 KPE04D 清玻片 Clear glass

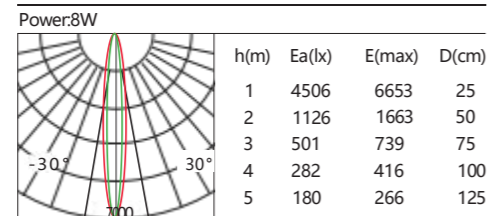

Beam Angle 15° Luminous flux(lm):755 I_{max}(cd):6653



Type:Spotlight-KPEADLAS15W
 Voltage:220-240V/50Hz
 Power:15W
 Color Temperature: 2700K/3000K/4000K/5000K
 Luminous Flux:1350lm
 CRI:Ra>90
 Beam Angle:15° /24° /36°
 Color:White+Black+Grey
 Material:Aluminium
 Size:97*120mm
 Cutout:80mm
 Chips:Cree
 Driver:LiFud/PF>0.9
 Life span:30000 hours

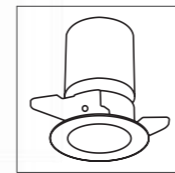

灯具类型: 射灯 -KPEADLAS15W
 电压: 220-240V/50Hz
 功率: 15W
 色温: 2700K/3000K/4000K/5000K
 光通量: 1350lm
 显色指数: Ra>90
 光束角: 15度 /24度 /36度
 颜色: 白+黑+灰
 材质: 铝材质
 尺寸: 97*120mm
 开孔: 80mm
 光源: 科锐
 电源: 莱福德电源 /PF>0.9
 光源寿命: 30000 小时



光学配件 / REFLECTING ACCESSORIES



可选必须 / OPTIONAL MUST
 KPE00A 斜口反光下罩真空镀银 Reflector(mirror)
 KPE00B 斜口反光下罩喷漆 - DW White oblique mouth reflective cover
 KPE00C U形孔反光下罩喷漆 - DW/BK U shaped hole reflective cover

光学配件 / OPTICAL ACCESSORIES



可选 / 不必要 / OPTIONAL / NOT NECESSARY
 KPE01A 柔光镜 soft lens
 KPE02B 蜂窝网 honeycomb
 KPE03C 拉伸镜 striation glass
 KPE04D 清玻片 Clear glass

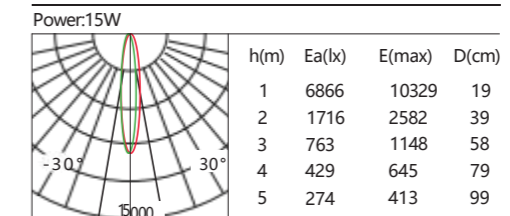

Beam Angle 15° Luminous flux(lm):638 I_{max}(cd):10329

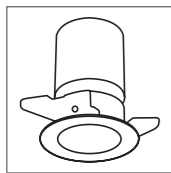

Type:Spotlight-KPEADLAS26W
 Voltage:220-240V/50Hz
 Power:26W
 Color Temperature: 2700K/3000K/4000K/5000K
 Luminous Flux:2400lm
 CRI:Ra>90
 Beam Angle:15° /24° /36°
 Color:White+Black+Grey
 Material:Aluminium
 Size:120*137mm
 Cutout:100mm
 Chips:Cree
 Driver:LiFud/PF>0.9
 Life span:30000 hours

灯具类型: 射灯 -KPEADLAS26W
 电压: 220-240V/50Hz
 功率: 26W
 色温: 2700K/3000K/4000K/5000K
 光通量: 2400lm
 显色指数: Ra>90
 光束角: 15度 /24度 /36度
 颜色: 白 + 黑 + 灰
 材质: 铝材质
 尺寸: 120*137mm
 开孔: 100mm
 光源: 科锐
 电源: 莱福德电源 /PF>0.9
 光源寿命: 30000 小时



光学配件 / REFLECTING ACCESSORIES



可选必须 / OPTIONAL MUST
 KPE00A 斜口反光下罩真空镀银 Reflector(mirror)
 KPE00B 斜口反光下罩喷漆 - DW White oblique mouth reflective cover
 KPE00C U形孔反光下罩喷漆 - DW/BK U shaped hole reflective cover

光学配件 / OPTICAL ACCESSORIES



可选 / 不必要 / OPTIONAL / NOT NECESSARY
 KPE01A 柔光镜 soft lens
 KPE02B 蜂窝网 honeycomb
 KPE03C 拉伸镜 striation glass
 KPE04D 清玻片 Clear glass

Power:26W

h(m)	Ea(lx)	E(max)	D(cm)
1	14361	21347	20
2	3590	5337	40
3	1596	2372	60
4	897	1334	80
5	574	853	100

Beam Angle 15° Luminous flux(lm):1345 Imax(cd):21347

Luminaire arrangement

15°

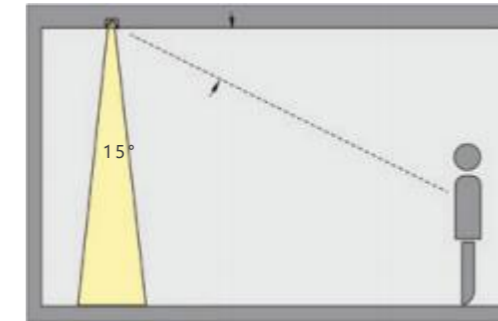

24°

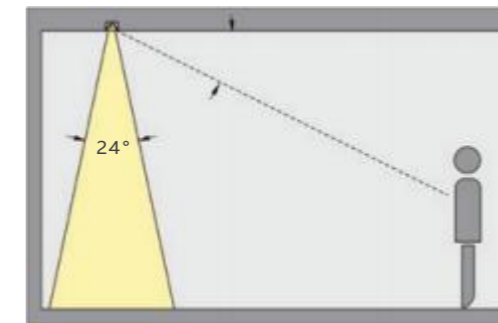

36°

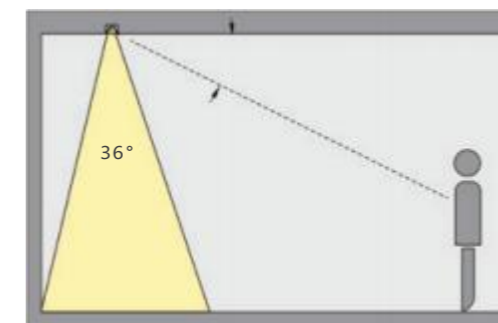

LED
FIXED DOWNLIGHT
Apollo Series

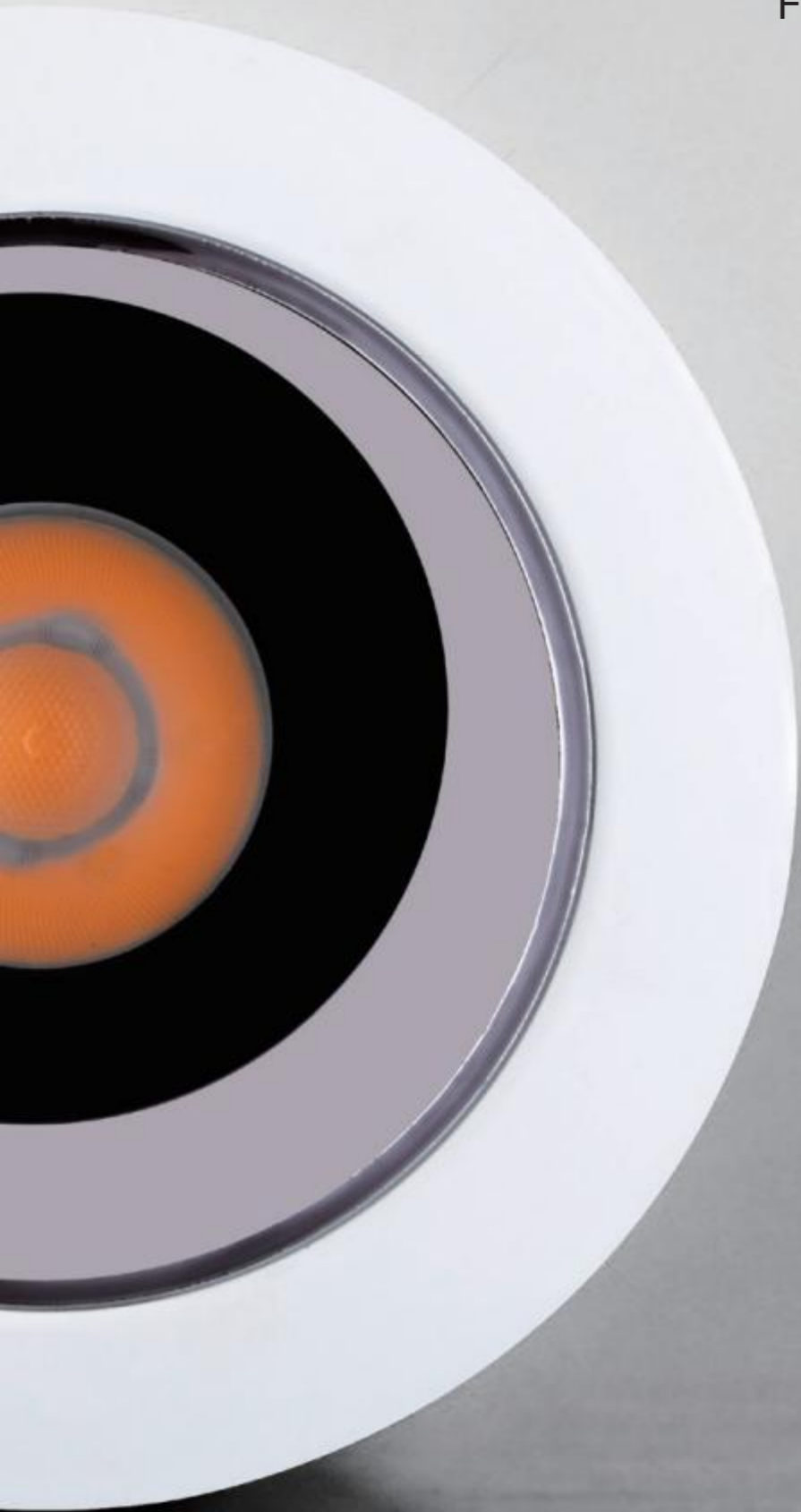

LED Fixed Downlight—Apollo Series
LED 下照式筒灯——阿波罗系列



Downlight 筒灯：

Apollo series fixed downlight adopts the new black reflector technique, 3 cutout size, dimming and non-dimming type, 4 beam angle, can satisfy various design application demand. It can be used in hotel, house, villa, square and high-end shop, etc. It provides enough meaty imagination and visual experience for designer and its space.

阿波罗系列下照式筒灯采用全新黑光杯光学结构，3种开孔尺寸，可调光与不可调光2种照明类型，4种光束角度，满足多种设计应用需求，广泛应用于酒店、家居、别墅、广场、高端店铺等商业综合体，为设计师和设计空间提供足够丰满的灯光想象空间和视觉冲击体验。



Type:Downlight-KPEFDLAS8W
 Voltage:220-240V/50Hz
 Power:8W
 Color Temperature: 2700K/3000K/4000K/5000K
 Luminous Flux:750lm
 CRI:Ra>90
 Beam Angle:15° /24° /36°
 Color:White+Grey
 Material:Aluminium
 Size:70*78mm
 Cutout:55mm
 Chips:Cree
 Driver:LiFud/PF>0.9
 Life span:30000 hours

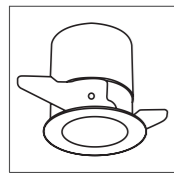

灯具类型:筒灯-KPEFDLAS8W
 电压:220-240V/50Hz
 功率:8W
 色温:2700K/3000K/4000K/5000K
 光通量:750lm
 显色指数:Ra>90
 光束角:15度/24度/36度
 颜色:白+灰
 材质:铝材质
 尺寸:70*78mm
 开孔:55mm
 光源:科锐
 电源:莱福德电源/PF>0.9
 光源寿命:30000小时



光学配件 / REFLECTING ACCESSORIES



可选必须 / OPTIONAL MUST
 KPE00A 斜口反光下罩真空镀膜 Reflector(mirror)
 KPE00B 斜口反光下罩喷漆 - DW White oblique mouth reflective cover
 KPE00C U形孔反光下罩喷漆 - DW/BK U shaped hole reflective cover

光学配件 / OPTICAL ACCESSORIES

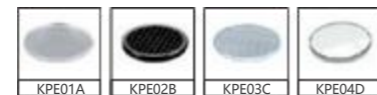

可选 / 不必要 / OPTIONAL / NOT NECESSARY
 KPE01A 柔光镜 soft lens
 KPE02B 蜂窝网 honeycomb
 KPE03C 拉伸镜 striation glass
 KPE04D 清玻片 Clear glass

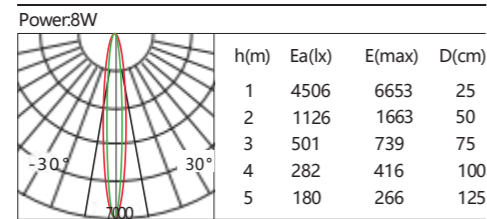

Beam Angle 15° Luminous flux(lm):755 Imax(cd):6653



Type:Downlight-KPEFDLAS15W
 Voltage:220-240V/50Hz
 Power:15W
 Color Temperature: 2700K/3000K/4000K/5000K
 Luminous Flux:1350lm
 CRI:Ra>90
 Beam Angle:15° /24° /36°
 Color:White+Grey
 Material:Aluminium
 Size:97*100mm
 Cutout:80mm
 Chips:Cree
 Driver:LiFud/PF>0.9
 Life span:30000 hours

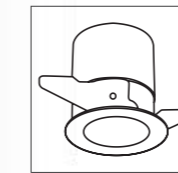

灯具类型:筒灯-KPEFDLAS15W
 电压:220-240V/50Hz
 功率:15W
 色温:2700K/3000K/4000K/5000K
 光通量:1350lm
 显色指数:Ra>90
 光束角:15度/24度/36度
 颜色:白+灰
 材质:铝材质
 尺寸:97*95mm
 开孔:80mm
 光源:科锐
 电源:莱福德电源/PF>0.9
 光源寿命:30000小时



光学配件 / REFLECTING ACCESSORIES



可选必须 / OPTIONAL MUST
 KPE00A 斜口反光下罩真空镀膜 Reflector(mirror)
 KPE00B 斜口反光下罩喷漆 - DW White oblique mouth reflective cover
 KPE00C U形孔反光下罩喷漆 - DW/BK U shaped hole reflective cover

光学配件 / OPTICAL ACCESSORIES



可选 / 不必要 / OPTIONAL / NOT NECESSARY
 KPE01A 柔光镜 soft lens
 KPE02B 蜂窝网 honeycomb
 KPE03C 拉伸镜 striation glass
 KPE04D 清玻片 Clear glass

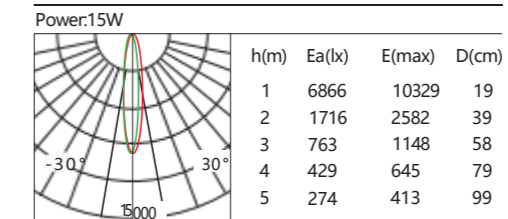

Beam Angle 15° Luminous flux(lm):638 Imax(cd):10329



Type:Downlight-KPEFDLAS26W
 Voltage:220-240V/50Hz
 Power:26W
 Color Temperature: 2700K/3000K/4000K/5000K
 Luminous Flux:2400lm
 CRI:Ra>90
 Beam Angle:15° /24° /36°
 Color:White+Grey
 Material:Aluminium
 Size:120*107mm
 Cutout:100mm
 Chips:Cree
 Driver:LiFud/PF>0.9
 Life span:30000 hours

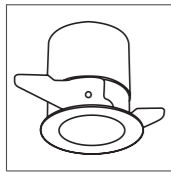

灯具类型:筒灯-KPEFDLAS26W
 电压:220-240V/50Hz
 功率:26W
 色温:2700K/3000K/4000K/5000K
 光通量:2400lm
 显色指数:Ra>90
 光束角:15度/24度/36度
 颜色:白+灰
 材质:铝材质
 尺寸:120*107mm
 开孔:100mm
 光源:科锐
 电源:莱福德电源/PF>0.9
 光源寿命:30000小时



光学配件 / REFLECTING ACCESSORIES



可选必须 / OPTIONAL MUST
 KPE00A 斜口反光下罩真空镀银 Reflector(mirror)
 KPE00B 斜口反光下罩喷漆 - DW White oblique mouth reflective cover
 KPE00C U形孔反光下罩喷漆 - DW/BK U shaped hole reflective cover

光学配件 / OPTICAL ACCESSORIES

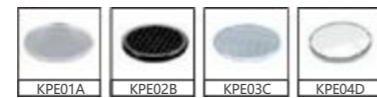

可选 / 不必要 / OPTIONAL / NOT NECESSARY
 KPE01A 柔光镜 soft lens
 KPE02B 蜂窝网 honeycomb
 KPE03C 拉伸镜 striation glass
 KPE04D 清玻片 Clear glass

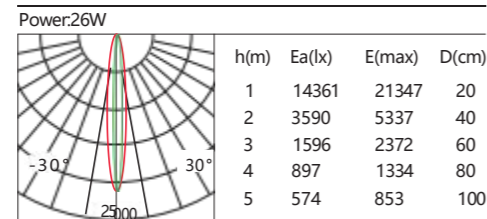

Beam Angle 15° Luminous flux(lm):1345 Imax(cd):21347

嵌入式照明灯具布置图
 Luminaire arrangement

15°

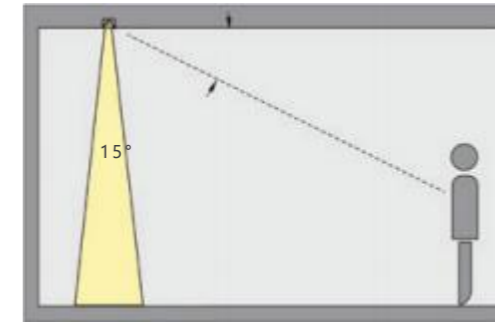

24°

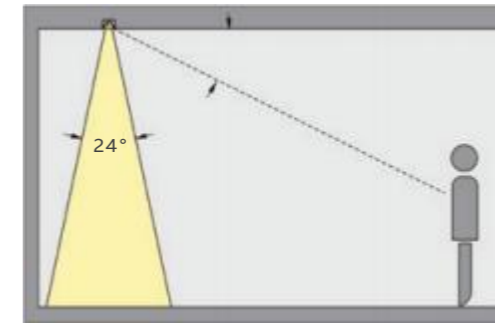

36°

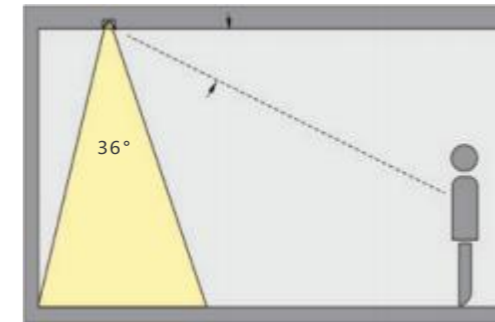



LED
WALL WASHER
Luna Series

LED Wall Washer—Luna Series
LED 洗墙筒灯——露娜系列



KPEWWLS6W

KPEWWLS15W

KPEWWLS24W

Wall Washer 洗墙灯：

Luna series is one kind of recessed luminaires of LED light,mainly control light direction by special reflector and make light wash the wall like the water softly without messy,so that it owns the excellent no-glare design and light effect and is used in hotel,public,cinema,supermarket and any other widely,playing a very important role in basic lighting and decoration lighting.

露娜系列洗墙灯属于嵌入式灯具的一种，主要通过特殊设计的反光罩控制光束的投方向，令光如同水般洗过墙面，柔和均匀，无副光斑，极佳的防眩设计和灯光效果，使露娜系列可广泛应用于酒店、公共场所、影院、商场等商业空间内，起到了洗墙装饰和基础照射的灯具照明功能。



Type:Wall washer-KPEWWS6W
 Voltage:220-240V/50Hz
 Power:6W
 Color Temperature: 2700K/3000K/4000K/5000K
 Luminous Flux:540lm
 CRI:Ra>90
 Beam Angle:Wallwashing
 Color:White/Black/Grey
 Material:Aluminium
 Size:85*25mm
 Cutout:70-75mm
 Chips:Cree
 Driver:LiFud/PF>0.9
 Life span:30000 hours

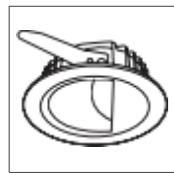

灯具类型: 洗墙灯 -KPEWWS6W
 电压: 220-240V/50Hz
 功率: 6W
 色温: 2700K/3000K/4000K/5000K
 光通量: 540lm
 显色指数: Ra>90
 光束角: 偏光洗墙
 颜色: 白/黑/灰
 材质: 压铸铝
 尺寸: 85*25mm
 开孔: 70-75mm
 光源: 科锐芯片
 电源: 莱福德电源 /PF>0.9
 光源寿命: 30000 小时



光学配件 / REFLECTING ACCESSORIES



可选必须 / OPTIONAL MUST
 KPE00A 斜口反光下罩真空镀膜 Reflector(mirror)
 KPE00B 斜口反光下罩喷漆 - DW White oblique mouth reflective cover
 KPE00C U形孔反光下罩喷漆 - DW/BK U shaped hole reflective cover

光学配件 / OPTICAL ACCESSORIES

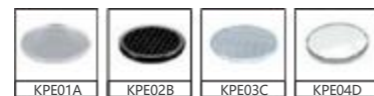

可选 / 不必要 / OPTIONAL / NOT NECESSARY
 KPE01A 柔光镜 soft lens
 KPE02B 蜂窝网 honeycomb
 KPE03C 拉伸镜 striation glass
 KPE04D 清玻片 Clear glass

Power:6W

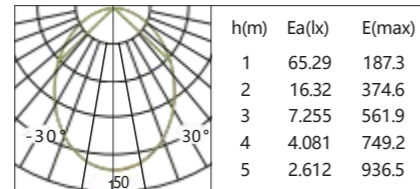

Beam Angle 120°



Type:Wall washer-KPEWWS15W
 Voltage:220-240V/50Hz
 Power:15W
 Color Temperature: 2700K/3000K/4000K/5000K
 Luminous Flux:1350lm
 CRI:Ra>90
 Beam Angle:Wallwashing
 Color:White/Black/Grey
 Material:Aluminium
 Size:103*33mm
 Cutout:90mm
 Chips:Cree
 Driver:LiFud/PF>0.9
 Life span:30000 hours

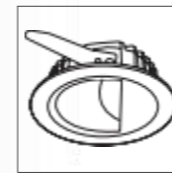

灯具类型: 洗墙灯 -KPEWWS15W
 电压: 220-240V/50Hz
 功率: 15W
 色温: 2700K/3000K/4000K/5000K
 光通量: 1350lm
 显色指数: Ra>90
 光束角: 偏光洗墙
 颜色: 白/黑/灰
 材质: 压铸铝
 尺寸: 103*33mm
 开孔: 90mm
 光源: 科锐芯片
 电源: 莱福德电源 /PF>0.9
 光源寿命: 30000 小时



光学配件 / REFLECTING ACCESSORIES



可选必须 / OPTIONAL MUST
 KPE00A 斜口反光下罩真空镀膜 Reflector(mirror)
 KPE00B 斜口反光下罩喷漆 - DW White oblique mouth reflective cover
 KPE00C U形孔反光下罩喷漆 - DW/BK U shaped hole reflective cover

光学配件 / OPTICAL ACCESSORIES

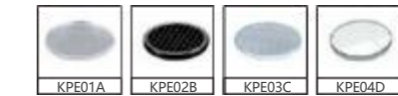

可选 / 不必要 / OPTIONAL / NOT NECESSARY
 KPE01A 柔光镜 soft lens
 KPE02B 蜂窝网 honeycomb
 KPE03C 拉伸镜 striation glass
 KPE04D 清玻片 Clear glass

Power:15W

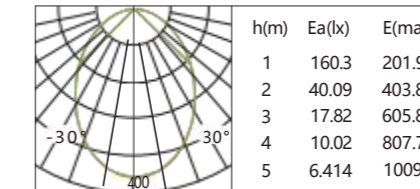

Beam Angle 120°



Type:Wall washer-KPEWWLS24W
 Voltage:220-240V/50Hz
 Power:24W
 Color Temperature: 2700K/3000K/4000K/5000K
 Luminous Flux:2150lm
 CRI:Ra>90
 Beam Angle:Wallwashing
 Color:White/Black/Grey
 Material:Aluminium
 Size:159*46mm
 Cutout:130-145mm
 Chips:Cree
 Driver:LiFud/PF>0.9
 Life span:30000 hours

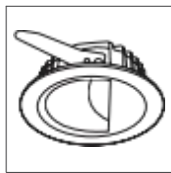

灯具类型: 洗墙灯 -KPEWWLS24W
 电压: 220-240V/50Hz
 功率: 24W
 色温: 2700K/3000K/4000K/5000K
 光通量: 2150lm
 显色指数: Ra>90
 光束角: 偏光洗墙
 颜色: 白/黑/灰
 材质: 压铸铝
 尺寸: 159*46mm
 开孔: 130-145mm
 光源: 科锐芯片
 电源: 莱福德电源 /PF>0.9
 光源寿命: 30000 小时



光学配件 / REFLECTING ACCESSORIES



可选必须 / OPTIONAL MUST
 KPE00A 斜口反光下罩真空镀银 Reflector(mirror)
 KPE00B 斜口反光下罩喷漆 - DW White oblique mouth reflective cover
 KPE00C U形孔反光下罩喷漆 - DW/BK U shaped hole reflective cover

光学配件 / OPTICAL ACCESSORIES



可选 / 不必要 / OPTIONAL / NOT NECESSARY
 KPE01A 柔光镜 soft lens
 KPE02B 蜂窝网 honeycomb
 KPE03C 拉伸镜 striation glass
 KPE04D 清玻片 Clear glass

Power:24W

h(m)	Ea(lx)	E(max)
1	14361	21347
2	3590	5337
3	1596	2372
4	897	1334
5	574	853

Beam Angle 120°

嵌入式照明灯具布置图
 Luminaire arrangement

应用一: 洗墙灯 (wall washlights)



应用一: 洗地灯 (floor washlights)

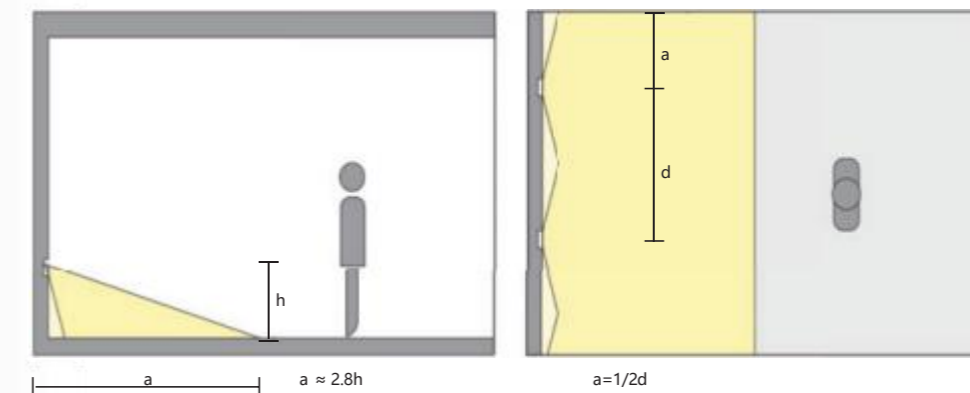



LED Downlight—Eros Series (Emergency Function)
LED 筒灯—艾罗斯系列 (应急功能)



LED
DOWNLIGHT
Eros Series (Emergency Function)

Downlight 筒灯 :

Eros series downlight can perfectly provide the excellent lighting effects not only in the giant commercial synthesis but also in every independent commercial space.High CRI、high lumen and the lighting is non-glare for UGR<15 then softly resonating all the characteristic of the space.

艾罗斯系列筒灯无论应用于大型商业综合体抑或在单独的商业店铺空间都能完美无瑕地呈现其出色的光效，高流明高显色以及 UGR<15 的防眩光设计能柔和地展现每片区域的空间特点特征。



Type:Downlight-KPEDLES3W
 Voltage:220-240V/50Hz
 Power:3W
 Color Temperature: 3000K/4000K/6000K
 Luminous Flux:270lm
 CRI:Ra>80
 Beam Angle:120°
 Color:White+Black
 Material:PC+Aluminium
 Size:105*80mm
 Cutout:80-85mm
 Chips:Sanan
 Driver:Isolated/PF>0.9
 Life span:30000 hours

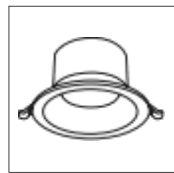

灯具类型:筒灯-KPEDLES3W
 电压:220-240V/50Hz
 功率:3W
 色温:3000K/4000K/6000K
 光通量:270lm
 显色指数:Ra>80
 光束角:120度
 颜色:白+黑
 材质:PC塑料+铝
 尺寸:105*80mm
 开孔:80-85mm
 光源:三安芯片
 电源:隔离电源/PF>0.9
 光源寿命:30000小时



Power:3W

h(m)	Ea(lx)	E(max)
1	49.78	206.79
2	12.45	413.58
3	5.531	620.37
4	3.111	827.16
5	1.991	1033.95

Beam Angle 120°



Type:Downlight-KPEDLES5W
 Voltage:220-240V/50Hz
 Power:5W
 Color Temperature: 3000K/4000K/6000K
 Luminous Flux:450lm
 CRI:Ra>80
 Beam Angle:120°
 Color:White+Black
 Material:PC+Aluminium
 Size:125*85mm
 Cutout:100mm
 Chips:Sanan
 Driver:Isolated/PF>0.9
 Life span:30000 hours

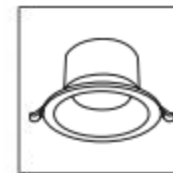

灯具类型:筒灯-KPEDLES5W
 电压:220-240V/50Hz
 功率:5W
 色温:3000K/4000K/6000K
 光通量:450lm
 显色指数:Ra>80
 光束角:120度
 颜色:白+黑
 材质:PC塑料+铝
 尺寸:125*85mm
 开孔:100mm
 光源:三安芯片
 电源:隔离电源/PF>0.9
 光源寿命:30000小时



Power:5W

h(m)	Ea(lx)	E(max)
1	65.29	187.3
2	16.32	374.6
3	7.255	561.9
4	4.081	749.2
5	2.612	936.5

Beam Angle 120°



Type:Downlight-KPEDLES9W
 Voltage:220-240V/50Hz
 Power:9W
 Color Temperature: 3000K/4000K/6000K
 Luminous Flux:800lm
 CRI:Ra>80
 Beam Angle:120°
 Color:White+Black
 Material:PC+Aluminium
 Size:150*88mm
 Cutout:120mm
 Chips:Sanan
 Driver:Isolated/PF>0.9
 Life span:30000 hours

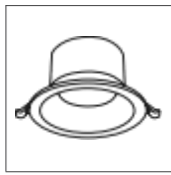

灯具类型:筒灯-KPEDLES9W
 电压:220-240V/50Hz
 功率:9W
 色温:3000K/4000K/6000K
 光通量:800lm
 显色指数:Ra>80
 光束角:120度
 颜色:白+黑
 材质:PC塑料+铝
 尺寸:150*88mm
 开孔:120mm
 光源:三安芯片
 电源:隔离电源/PF>0.9
 光源寿命:30000小时

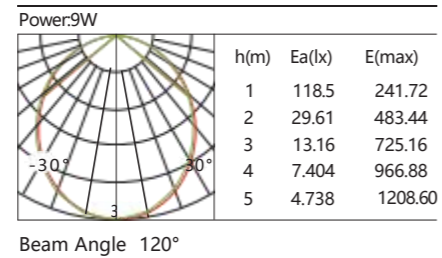

Type:Downlight-KPEDLES13W
 Voltage:220-240V/50Hz
 Power:13W
 Color Temperature: 3000K/4000K/6000K
 Luminous Flux:1170lm
 CRI:Ra>80
 Beam Angle:120°
 Color:White+Black
 Material:PC+Aluminium
 Size:175*97mm
 Cutout:150mm
 Chips:Sanan
 Driver:Isolated/PF>0.9
 Life span:30000 hours

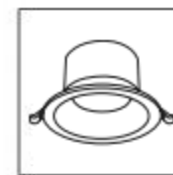

灯具类型:筒灯-KPEDLES13W
 电压:220-240V/50Hz
 功率:13W
 色温:3000K/4000K/6000K
 光通量:1170lm
 显色指数:Ra>80
 光束角:120度
 颜色:白+黑
 材质:PC塑料+铝
 尺寸:175*97mm
 开孔:150mm
 光源:三安芯片
 电源:隔离电源/PF>0.9
 光源寿命:30000小时

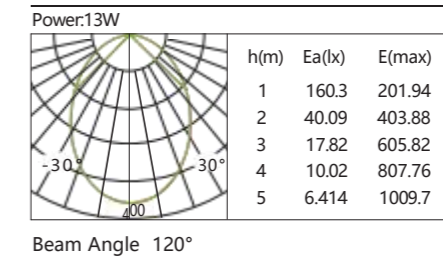



LED
LINE SPOTLIGHT
Laser Series

LED Line Spotlight—Laser Series
LED 线条射灯——雷蛇系列



KPELSLLS2W



KPELSLLS4W



KPELSLLS10W



KPELSLLS20W



KPELSLLS30W



Type:Spotlight-KPELSLLS2W
 Voltage:220-240V/50Hz
 Power:2W
 Color Temperature: 2700K/3000K/4000K/6000K
 Luminous Flux:175lm
 CRI:Ra>90
 Beam Angle:15° /30° /45°
 Color:White+Black
 Material:Aluminium
 Size:45*45*40mm
 Cutout:37*37mm
 Chips:Osram
 Driver:LiFud/PF>0.9
 Life span:30000 hours

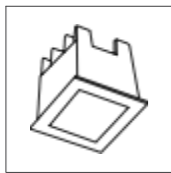

灯具类型: 射灯 -KPELSLLS2W
 电压: 220-240V/50Hz
 功率: 2W
 色温: 2700K/3000K/4000K/6000K
 光通量: 175lm
 显色指数: Ra>90
 光束角: 15度 /30度 /45度
 颜色: 白 + 黑
 材质: 压铸铝
 尺寸: 45*45*40mm
 开孔: 37*37mm
 光源: 欧司朗
 电源: 莱福德电源 /PF>0.9
 光源寿命: 30000小时

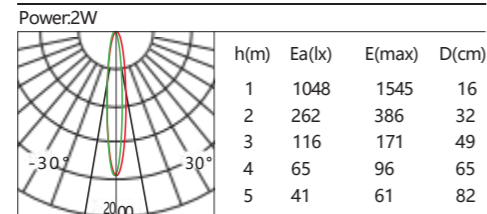

Beam Angle 15° Luminous flux(lm):131 I_{max}(cd):1548



Type:Spotlight-KPELSLLS4W
 Voltage:220-240V/50Hz
 Power:4W
 Color Temperature: 2700K/3000K/4000K/6000K
 Luminous Flux:350lm
 CRI:Ra>90
 Beam Angle:15° /30° /45°
 Color:White+Black
 Material:Aluminium
 Size:75*45*40mm
 Cutout:67*37mm
 Chips:Osram
 Driver:LiFud/PF>0.9
 Life span:30000 hours



灯具类型: 射灯 -KPELSLLS4W
 电压: 220-240V/50Hz
 功率: 4W
 色温: 2700K/3000K/4000K/6000K
 光通量: 350lm
 显色指数: Ra>90
 光束角: 15度 /30度 /45度
 颜色: 白 + 黑
 材质: 压铸铝
 尺寸: 75*45*40mm
 开孔: 67*37mm
 光源: 欧司朗
 电源: 莱福德电源 /PF>0.9
 光源寿命: 30000小时

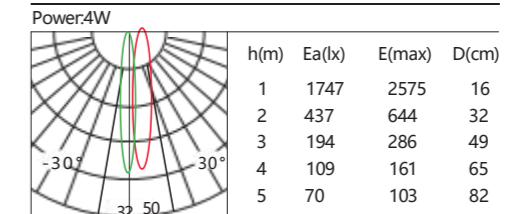

Beam Angle 15° Luminous flux(lm):219 I_{max}(cd):2580



Type:Spotlight-KPELSLLS10W
 Voltage:220-240V/50Hz
 Power:10W
 Color Temperature: 2700K/3000K/4000K/6000K
 Luminous Flux:900lm
 CRI:Ra>90
 Beam Angle:15° /30° /45°
 Color:White+Black
 Material:Aluminium
 Size:146*45*48mm
 Cutout:136*37mm
 Chips:Osram
 Driver:LiFud/PF>0.9
 Life span:30000 hours

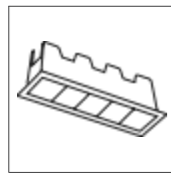

灯具类型: 射灯 -KPELSLLS10W
 电压: 220-240V/50Hz
 功率: 10W
 色温: 2700K/3000K/4000K/6000K
 光通量: 900lm
 显色指数: Ra>90
 光束角: 15度 /30度 /45度
 颜色: 白 + 黑
 材质: 压铸铝
 尺寸: 146*45*48mm
 开孔: 136*37mm
 光源: 欧司朗
 电源: 莱福德电源 /PF>0.9
 光源寿命: 30000 小时

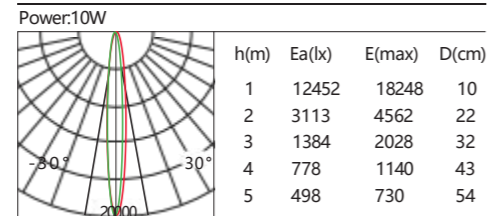

Beam Angle 15° Luminous flux(lm):415 I_{max}(cd):18248



Type:Spotlight-KPELSLLS20W
 Voltage:220-240V/50Hz
 Power:20W
 Color Temperature: 2700K/3000K/4000K/6000K
 Luminous Flux:1850lm
 CRI:Ra>90
 Beam Angle:15° /30° /45°
 Color:White+Black
 Material:Aluminium
 Size:280*45*48mm
 Cutout:270*37mm
 Chips:Osram
 Driver:LiFud/PF>0.9
 Life span:30000 hours

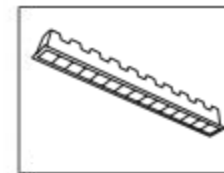

灯具类型: 射灯 -KPELSLLS20W
 电压: 220-240V/50Hz
 功率: 20W
 色温: 2700K/3000K/4000K/6000K
 光通量: 1850lm
 显色指数: Ra>90
 光束角: 15度 /30度 /45度
 颜色: 白 + 黑
 材质: 压铸铝
 尺寸: 280*45*48mm
 开孔: 270*37mm
 光源: 欧司朗
 电源: 莱福德电源 /PF>0.9
 光源寿命: 30000 小时

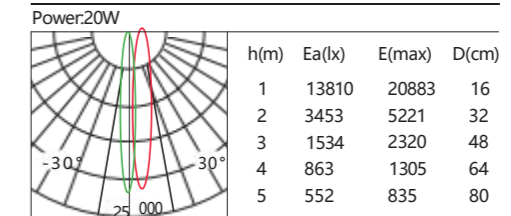

Beam Angle 15° Luminous flux(lm):993 I_{max}(cd):20893



Type:Spotlight-KPELSLLS30W
 Voltage:220-240V/50Hz
 Power:30W
 Color Temperature: 2700K/3000K/4000K/6000K
 Luminous Flux:2780lm
 CRI:Ra>90
 Beam Angle:15° /30° /45°
 Color:White+Black
 Material:Aluminium
 Size:413*45*48mm
 Cutout:403*37mm
 Chips:Osram
 Driver:LiFud/PF>0.9
 Life span:30000 hours

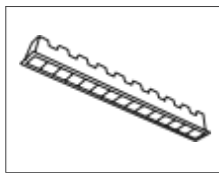

灯具类型: 射灯 -KPELSLLS30W
 电压: 220-240V/50Hz
 功率: 30W
 色温: 2700K/3000K/4000K/6000K
 光通量: 2780lm
 显色指数: Ra>90
 光束角: 15度 /30度 /45度
 颜色: 白 + 黑
 材质: 压铸铝
 尺寸: 413*45*48mm
 开孔: 403*37mm
 光源: 欧司朗
 电源: 莱福德电源 /PF>0.9
 光源寿命: 30000 小时

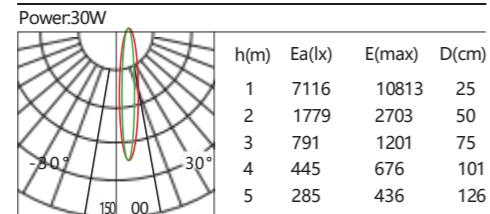

Beam Angle 15° Luminous flux(lm):1274 I_{max}(cd):10818

嵌入式照明灯具布置图
 Luminaire arrangement

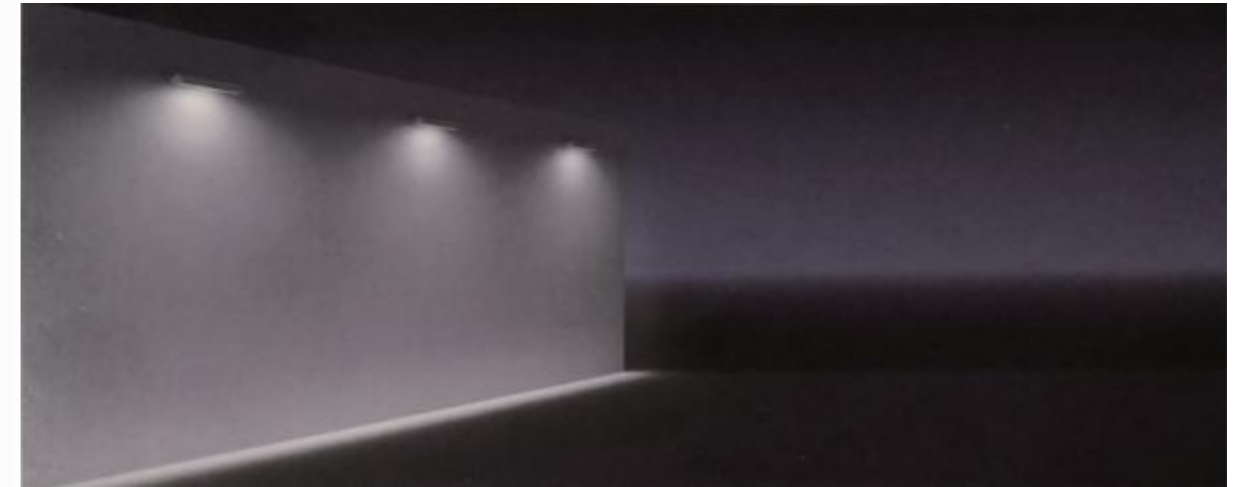

LED
LINE WALL WASHER
Ocean Series



LED Line Wall Washer—Ocean Series
LED 线条洗墙灯——海洋系列



KPELWOS10W



KPELWOS20W



KPELWOS30W



Type:Wall Washer-KPELWWOS10W
 Voltage:220-240V/50Hz
 Power:10W
 Color Temperature: 2700K/3000K/4000K/6000K
 Luminous Flux:900lm
 CRI:Ra>90
 Beam Angle:Wallwashing
 Color:White+Black
 Material:Aluminium
 Size:146*45*48mm
 Cutout:136*37mm
 Chips:Osram
 Driver:LiFud/PF>0.9
 Life span:30000 hours

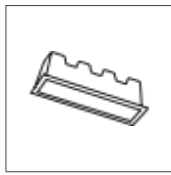

灯具类型: 洗墙灯 -KPELWWOS10W
 电压: 220-240V/50Hz
 功率: 10W
 色温: 2700K/3000K/4000K/6000K
 光通量: 900lm
 显色指数: Ra>90
 光束角: 偏光洗墙
 颜色: 白 + 黑
 材质: 压铸铝
 尺寸: 146*45*48mm
 开孔: 136*37mm
 光源: 欧司朗
 电源: 莱福德电源 /PF>0.9
 光源寿命: 30000 小时



Power:10W

h(m)	Ea(lx)	E(max)
1	12452	18248
2	3113	4562
3	1384	2028
4	778	1140
5	498	730

Beam Angle 120°



Type:Wall Washer-KPELWWOS20W
 Voltage:220-240V/50Hz
 Power:20W
 Color Temperature: 2700K/3000K/4000K/6000K
 Luminous Flux:1850lm
 CRI:Ra>90
 Beam Angle:Wallwashing
 Color:White+Black
 Material:Aluminium
 Size:280*45*48mm
 Cutout:270*37mm
 Chips:Osram
 Driver:LiFud/PF>0.9
 Life span:30000 hours

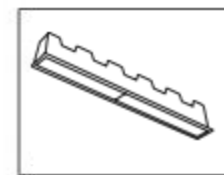

灯具类型: 洗墙灯 -KPELWWOS20W
 电压: 220-240V/50Hz
 功率: 20W
 色温: 2700K/3000K/4000K/6000K
 光通量: 1850lm
 显色指数: Ra>90
 光束角: 偏光洗墙
 颜色: 白 + 黑
 材质: 压铸铝
 尺寸: 280*45*48mm
 开孔: 270*37mm
 光源: 欧司朗
 电源: 莱福德电源 /PF>0.9
 光源寿命: 30000 小时



Power:20W

h(m)	Ea(lx)	E(max)
1	13810	20883
2	3453	5221
3	1534	2320
4	863	1305
5	552	835

Beam Angle 120°

K-LUX

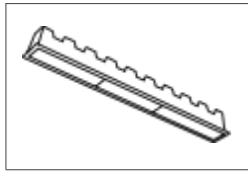

Type:Wall Washer-KPELWWOS30W
 Voltage:220-240V/50Hz
 Power:30W
 Color Temperature: 2700K/3000K/4000K/6000K
 Luminous Flux:2780lm
 CRI:Ra>90
 Beam Angle:Wallwashing
 Color:White+Black
 Material:Aluminium
 Size:413*45*48mm
 Cutout:403*37mm
 Chips:Osram
 Driver:LiFud/PF>0.9
 Life span:30000 hours

灯具类型: 洗墙灯 -KPELWWOS30W
 电压: 220-240V/50Hz
 功率: 30W
 色温: 2700K/3000K/4000K/6000K
 光通量: 2780lm
 显色指数: Ra>90
 光束角: 偏光洗墙
 颜色: 白 + 黑
 材质: 压铸铝
 尺寸: 413*45*48mm
 开孔: 403*37mm
 光源: 欧司朗
 电源: 莱福德电源 /PF>0.9
 光源寿命: 30000 小时



Power:30W

h(m)	Ea(lx)	E(max)
1	7116	10813
2	1779	2703
3	791	1201
4	445	676
5	285	436

Beam Angle 120°

嵌入式照明灯具布置图 Luminaire arrangement





LED
TRACKLIGHT
Blue Series

两种选择 随心所欲



LED Tracklight—Blue Series For Catering
LED 轨道射灯——湛蓝餐饮系列



KPETLBS15W



KPETLBS32W



Type:Spotlight-KPETLBS15W
 Voltage:220-240V/50Hz
 Power:15W
 Color Temperature: 2700K/3000K/4000K/5000K
 Luminous Flux:1400lm
 CRI:Ra>90
 Beam Angle:15° /24° /36°
 Color:White/Black/Grey
 Material:Aluminium
 Size:54*150mm
 Adapter:2/3/4-Circuit/Surface Mounted
 Chips:Cree/Luminus/Citizen
 Driver:Isolated/PF>0.9
 Life span:30000 hours

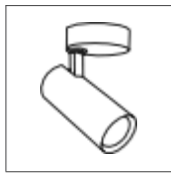

灯具类型: 射灯 -KPETLBS15W
 电压: 220-240V/50Hz
 功率: 15W
 色温: 2700K/3000K/4000K/5000K
 光通量: 1400lm
 显色指数: Ra>90
 光束角: 15度 /24度 /36度
 颜色: 白 / 黑 / 灰
 材质: 铝材
 尺寸: 54*150mm
 适配器: 2/3/4 线导轨式 / 吸顶式
 光源: 科锐 / 朗明纳斯 / 西铁城
 电源: 隔离电源 /PF>0.9
 光源寿命: 30000 小时



光学配件 / OPTICAL ACCESSORIES

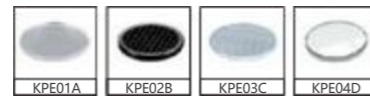

可选 / 不必要 / OPTIONAL / NOT NECESSARY
 KPE01A 柔光镜 soft lens
 KPE02B 蜂窝网 honeycomb
 KPE03C 拉伸镜 striation glass
 KPE04D 清玻片 Clear glass

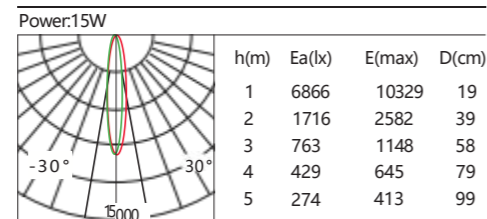

Beam Angle 15° Luminous flux(lm):638 I_{max}(cd):10329



Type:Spotlight-KPETLBS32W
 Voltage:220-240V/50Hz
 Power:32W
 Color Temperature: 2700K/3000K/4000K/5000K
 Luminous Flux:3050lm
 CRI:Ra>90
 Beam Angle:15° /24° /36°
 Color:White/Black/Grey
 Material:Aluminium
 Size:68*170mm
 Adapter:2/3/4-Circuit/Surface Mounted
 Chips:Cree/Luminus/Citizen
 Driver:Isolated/PF>0.9
 Life span:30000 hours

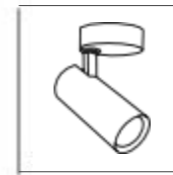

灯具类型: 射灯 -KPETLBS32W
 电压: 220-240V/50Hz
 功率: 32W
 色温: 2700K/3000K/4000K/5000K
 光通量: 3050lm
 显色指数: Ra>90
 光束角: 15度 /24度 /36度
 颜色: 白 / 黑 / 灰
 材质: 铝材
 尺寸: 68*170mm
 适配器: 2/3/4 线导轨式 / 吸顶式
 光源: 科锐 / 朗明纳斯 / 西铁城
 电源: 隔离电源 /PF>0.9
 光源寿命: 30000 小时



光学配件 / OPTICAL ACCESSORIES



可选 / 不必要 / OPTIONAL / NOT NECESSARY
 KPE01A 柔光镜 soft lens
 KPE02B 蜂窝网 honeycomb
 KPE03C 拉伸镜 striation glass
 KPE04D 清玻片 Clear glass

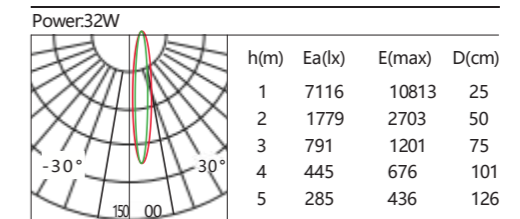

Beam Angle 15° Luminous flux(lm):1274 I_{max}(cd):10818



LED
TRACKLIGHT
Vivid Series

LED Tracklight—Vivid Series For Clothing
LED 轨道射灯—绚彩服装系列



KPETLVS12W

KPETLVS25W

KPETLVS35W

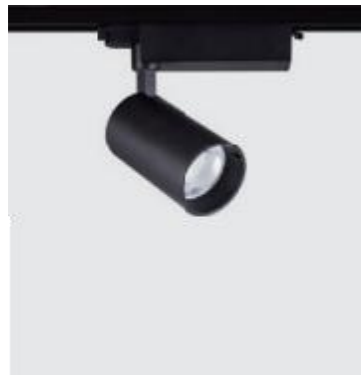

Type:Spotlight-KPETLVS12W
 Voltage:220-240V/50Hz
 Power:12W
 Color Temperature: 2700K/3000K/4000K/5000K
 Luminous Flux:1100lm
 CRI:Ra>90
 Beam Angle:15° /24° /36°
 Color:White/Black/Grey
 Material:Aluminium
 Size:67*151mm
 Adapter:2/3/4-Circuit/Surface Mounted
 Chips:Cree/Luminus/Citizen
 Driver:LiFud/PF>0.9
 Life span:30000 hours

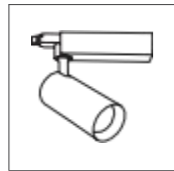

灯具类型: 射灯 -KPETLVS12W
 电压: 220-240V/50Hz
 功率: 12W
 色温: 2700K/3000K/4000K/5000K
 光通量: 1100lm
 显色指数: Ra>90
 光束角: 15度 /24度 /36度
 颜色: 白 / 黑 / 灰
 材质: 铝材
 尺寸: 67*151mm
 适配器: 2/3/4 线导轨式 / 吸顶式
 光源: 科锐 / 朗明纳斯 / 西铁城
 电源: 莱福德电源 /PF>0.9
 光源寿命: 30000 小时



光学配件 / OPTICAL ACCESSORIES



可选 / 不必要 / OPTIONAL / NOT NECESSARY
 KPE01A 柔光镜 soft lens
 KPE02B 蜂窝网 honeycomb
 KPE03C 拉伸镜 striation glass
 KPE04D 清玻片 Clear glass

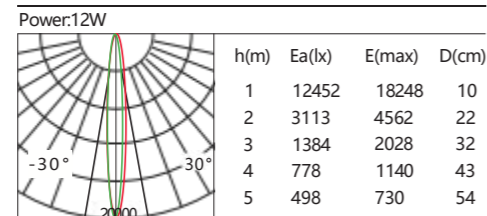

Beam Angle 15° Luminous flux(lm):415 Imax(cd):18248

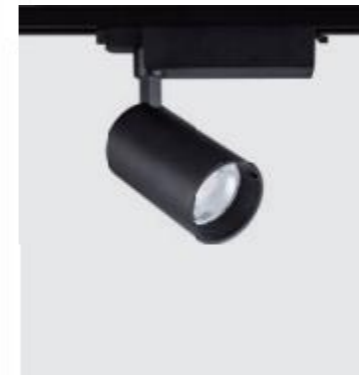

Type:Spotlight-KPETLVS25W
 Voltage:220-240V/50Hz
 Power:25W
 Color Temperature: 2700K/3000K/4000K/5000K
 Luminous Flux:2350lm
 CRI:Ra>90
 Beam Angle:15° /24° /36°
 Color:White/Black/Grey
 Material:Aluminium
 Size:80*144mm
 Adapter:2/3/4-Circuit/Surface Mounted
 Chips:Cree/Luminus/Citizen
 Driver:LiFud/PF>0.9
 Life span:30000 hours

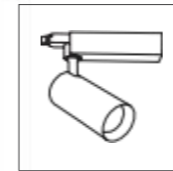

灯具类型: 射灯 -KPETLVS25W
 电压: 220-240V/50Hz
 功率: 25W
 色温: 2700K/3000K/4000K/5000K
 光通量: 2350lm
 显色指数: Ra>90
 光束角: 15度 /24度 /36度
 颜色: 白 / 黑 / 灰
 材质: 铝材
 尺寸: 80*144mm
 适配器: 2/3/4 线导轨式 / 吸顶式
 光源: 科锐 / 朗明纳斯 / 西铁城
 电源: 莱福德电源 /PF>0.9
 光源寿命: 30000 小时



光学配件 / OPTICAL ACCESSORIES

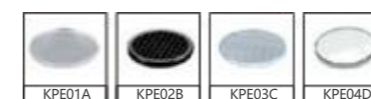

可选 / 不必要 / OPTIONAL / NOT NECESSARY
 KPE01A 柔光镜 soft lens
 KPE02B 蜂窝网 honeycomb
 KPE03C 拉伸镜 striation glass
 KPE04D 清玻片 Clear glass

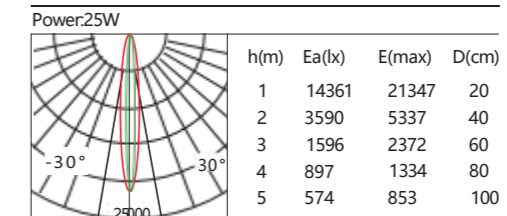

Beam Angle 15° Luminous flux(lm):1345 Imax(cd):21347

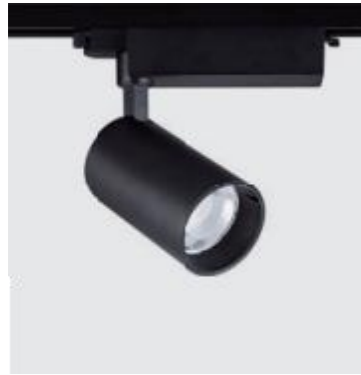

Type:Spotlight-KPETLVS35W
 Voltage:220-240V/50Hz
 Power:35W
 Color Temperature: 2700K/3000K/4000K/5000K
 Luminous Flux:3300lm
 CRI:Ra>90
 Beam Angle:15° /24° /36°
 Color:White/Black/Grey
 Material:Aluminium
 Size:90*155mm
 Adapter:2/3/4-Circuit/Surface Mounted
 Chips:Cree/Luminus/Citizen
 Driver:LiFud/PF>0.9
 Life span:30000 hours

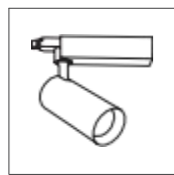

灯具类型: 射灯 -KPETLVS35W
 电压: 220-240V/50Hz
 功率: 35W
 色温: 2700K/3000K/4000K/5000K
 光通量: 3300lm
 显色指数: Ra>90
 光束角: 15度 /24度 /36度
 颜色: 白 / 黑 / 灰
 材质: 铝材
 尺寸: 90*155mm
 适配器: 2/3/4 线导轨式 / 吸顶式
 光源: 科锐 / 朗明纳斯 / 西铁城
 电源: 莱福德电源 /PF>0.9
 光源寿命: 30000 小时



光学配件 / OPTICAL ACCESSORIES

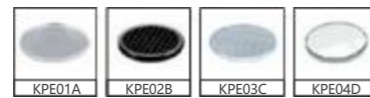

可选 / 不必要 / OPTIONAL / NOT NECESSARY
 KPE01A 柔光镜 soft lens
 KPE02B 蜂窝网 honeycomb
 KPE03C 拉伸镜 striation glass
 KPE04D 清玻片 Clear glass

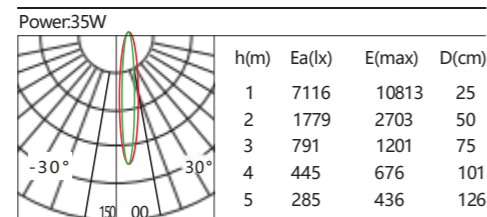

Beam Angle 15° Luminous flux(lm):1274 I_{max}(cd):10818



LED
 GRILLE SPOTLIGHT
 Maco Series

LED Grille Spotlight—Maco Series
LED 格栅射灯——玛克系列



KPEGSLMS25W

KPEGSLMS25W*1

KPEGSLMS25W*2



Type:Spotlight-Round-KPEGSLMS25W
Voltage:220-240V/50Hz
Power:25W
Color Temperature: 2700K/3000K/4000K/5000K
Luminous Flux:2350lm
CRI:Ra>90
Beam Angle:15° /24° /36°
Color:White+Black
Material:Aluminium
Size:161*123mm
Cutout:145mm
Chips:Cree/Luminus/Citizen
Driver:LiFud/PF>0.9
Life span:30000 hours

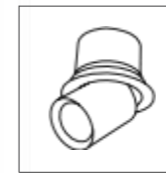

灯具类型: 射灯 - 圆 -KPEGSLMS25W
电压: 220-240V/50Hz
功率: 25W
色温: 2700K/3000K/4000K/5000K
光通量: 2350lm
显色指数: Ra>90
光束角: 15度/24度/36度
颜色: 白+黑
材质: 压铸铝
尺寸: 161*123mm
开孔: 145mm
光源: 科锐/朗明纳斯/西铁城
电源: 莱福德电源/PF>0.9
光源寿命: 30000小时



光学配件 / OPTICAL ACCESSORIES



可选 / 不必要 / OPTIONAL / NOT NECESSARY
KPE01A 柔光镜 soft lens
KPE02B 蜂窝网 honeycomb
KPE03C 拉伸镜 striation glass
KPE04D 清玻片 Clear glass

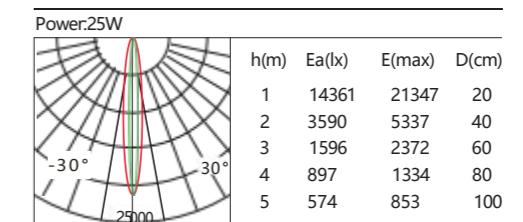

Beam Angle 15° Luminous flux(lm):1345 I_{max}(cd):21347



Type:Spotlight-Square-KPEGSLMS25W*1
 Voltage:220-240V/50Hz
 Power:25W
 Color Temperature: 2700K/3000K/4000K/5000K
 Luminous Flux:2350lm
 CRI:Ra>90
 Beam Angle:15° /24° /36°
 Color:White+Black
 Material:Aluminium
 Size:161*161*123mm
 Cutout:145*145mm
 Chips:Cree/Luminus/Citizen
 Driver:LiFud/PF>0.9
 Life span:30000 hours

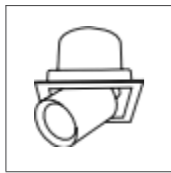

灯具类型: 射灯 - 方 -KPEGSLMS25W*1
 电压: 220-240V/50Hz
 功率: 25W
 色温: 2700K/3000K/4000K/5000K
 光通量: 2350lm
 显色指数: Ra>90
 光束角: 15度 /24度 /36度
 颜色: 白 + 黑
 材质: 压铸铝
 尺寸: 161*161*123mm
 开孔: 145*145mm
 光源: 科锐 / 朗明纳斯 / 西铁城
 电源: 莱福德电源 /PF>0.9
 光源寿命: 30000 小时



光学配件 / OPTICAL ACCESSORIES

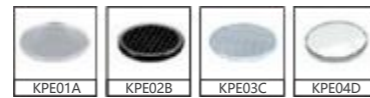

可选 / 不必要 / OPTIONAL / NOT NECESSARY
 KPE01A 柔光镜 soft lens
 KPE02B 蜂窝网 honeycomb
 KPE03C 拉伸镜 striation glass
 KPE04D 清玻片 Clear glass

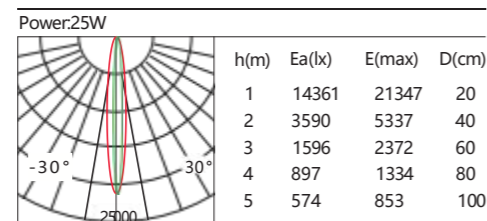

Beam Angle 15° Luminous flux(lm):1345 Imax(cd):21347



Type:Spotlight-Square-KPEGSLMS25W*2
 Voltage:220-240V/50Hz
 Power:25W*2
 Color Temperature: 2700K/3000K/4000K/5000K
 Luminous Flux:4700lm
 CRI:Ra>90
 Beam Angle:15° /24° /36°
 Color:White+Black
 Material:Aluminium
 Size:161*295*123mm
 Cutout:140*270mm
 Chips:Cree/Luminus/Citizen
 Driver:LiFud/PF>0.9
 Life span:30000 hours

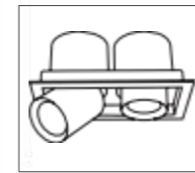

灯具类型: 射灯 - 方 -KPEGSLMS25W*2
 电压: 220-240V/50Hz
 功率: 25W*2
 色温: 2700K/3000K/4000K/5000K
 光通量: 4700lm
 显色指数: Ra>90
 光束角: 15度 /24度 /36度
 颜色: 白 + 黑
 材质: 压铸铝
 尺寸: 161*295*123mm
 开孔: 140*270mm
 光源: 科锐 / 朗明纳斯 / 西铁城
 电源: 莱福德电源 /PF>0.9
 光源寿命: 30000 小时



光学配件 / OPTICAL ACCESSORIES



可选 / 不必要 / OPTIONAL / NOT NECESSARY
 KPE01A 柔光镜 soft lens
 KPE02B 蜂窝网 honeycomb
 KPE03C 拉伸镜 striation glass
 KPE04D 清玻片 Clear glass

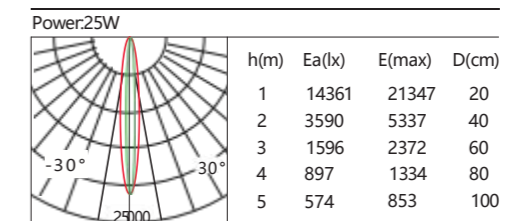

Beam Angle 15° Luminous flux(lm):1345 Imax(cd):21347



LED
TRUNK LIGHT
Nature Series

LED Trunk Light-Nature Series
LED 象鼻射灯——自然系列

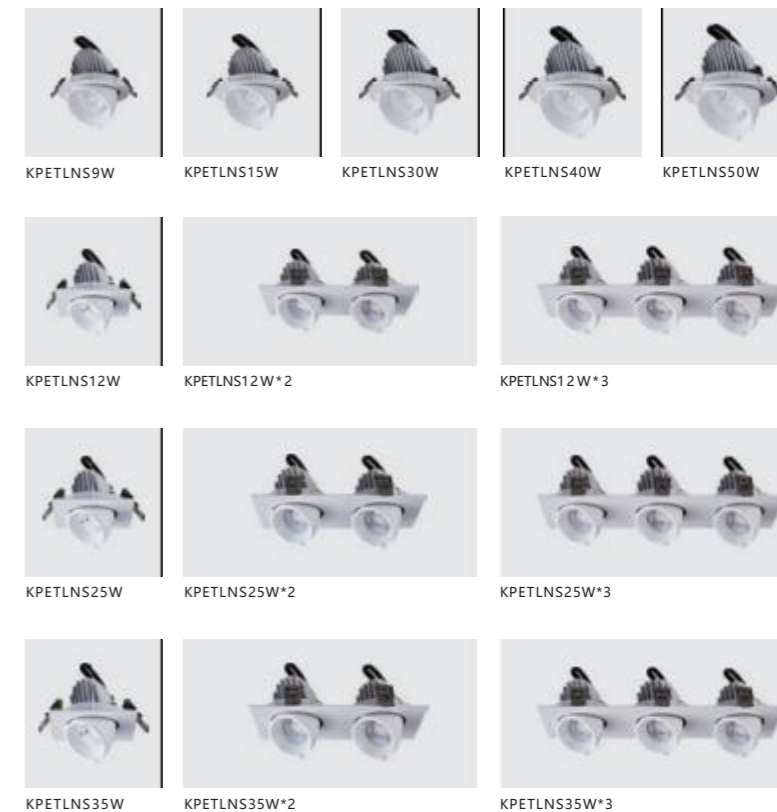

Spotlight 射灯 :

Adjust the transmitted light according to the different application sites. Die-casting lamp lighting design, no glare and high photosynthetic efficiency in both at the same time, the optical technology combined with classic implicit structure design, create a decorous, delicate, romantic commercial space lighting. Applicable to large commercial chain stores, departure stores, shops, DIY shops, showrooms, hotels, museums, restaurants and bars. High lighting contrast, mainly focus on key areas

根据不同应用场所调整透射光，压铸灯体结合灯光设计，再兼顾无眩光和高光效的同时，把光学技术特性与经典含蓄的结构设计结合起来，创造具有高雅的、精致的、浪漫的商业空间照明。适用于大型商业连锁店、百货商店、商铺、DIY店、展示厅、酒店、博物馆、餐厅、酒吧，强调较高的照明对比度，突出重点区域。



Type:Spotlight-KPETLNS9W
 Voltage:220-240V/50Hz
 Power:9W
 Color Temperature: 2700K/3000K/4000K/5000K
 Luminous Flux:800lm
 CRI:Ra>90
 Beam Angle:15° /24° /36°
 Color:White/Black/Grey
 Material:Aluminium
 Size:90*H75mm
 Cutout:75mm
 Chips:Cree/Luminus/Citizen
 Driver:LiFud/PF>0.9
 Life span:30000 hours



灯具类型: 射灯 -KPETLNS9W
 电压: 220-240V/50Hz
 功率: 9W
 色温: 2700K/3000K/4000K/5000K
 光通量: 800lm
 显色指数: Ra>90
 光束角: 15度/24度/36度
 颜色: 白/黑/灰
 材质: 压铸铝
 尺寸: 90*H75mm
 开孔: 75mm
 光源: 科锐/朗明纳斯/西铁城
 电源: 莱福德电源/PF>0.9
 光源寿命: 30000小时



光学配件 / OPTICAL ACCESSORIES

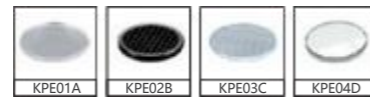

可选 / 不必要 / OPTIONAL / NOT NECESSARY
 KPE01A 柔光镜 soft lens
 KPE02B 蜂窝网 honeycomb
 KPE03C 拉伸镜 striation glass
 KPE04D 清玻片 Clear glass

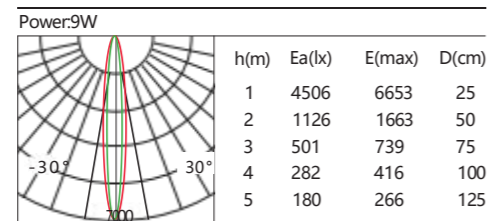

Beam Angle 15° Luminous flux(lm):755 Imax(cd):6653



Type:Spotlight-KPETLNS15W
 Voltage:220-240V/50Hz
 Power:15W
 Color Temperature: 2700K/3000K/4000K/5000K
 Luminous Flux:1400lm
 CRI:Ra>90
 Beam Angle:15° /24° /36°
 Color:White/Black/Grey
 Material:Aluminium
 Size:114*H80mm
 Cutout:100mm
 Chips:Cree/Luminus/Citizen
 Driver:LiFud/PF>0.9
 Life span:30000 hours



灯具类型: 射灯 -KPETLNS15W
 电压: 220-240V/50Hz
 功率: 15W
 色温: 2700K/3000K/4000K/5000K
 光通量: 1400lm
 显色指数: Ra>90
 光束角: 15度/24度/36度
 颜色: 白/黑/灰
 材质: 压铸铝
 尺寸: 114*H80mm
 开孔: 100mm
 光源: 科锐/朗明纳斯/西铁城
 电源: 莱福德电源/PF>0.9
 光源寿命: 30000小时



光学配件 / OPTICAL ACCESSORIES



可选 / 不必要 / OPTIONAL / NOT NECESSARY
 KPE01A 柔光镜 soft lens
 KPE02B 蜂窝网 honeycomb
 KPE03C 拉伸镜 striation glass
 KPE04D 清玻片 Clear glass

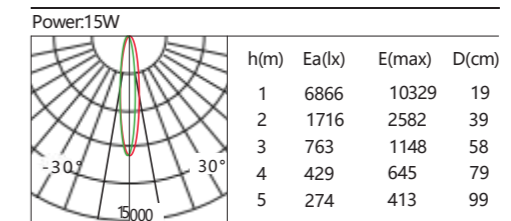

Beam Angle 15° Luminous flux(lm):638 Imax(cd):10329



Type:Spotlight-KPETLNS30W
 Voltage:220-240V/50Hz
 Power:30W
 Color Temperature: 2700K/3000K/4000K/5000K
 Luminous Flux:2850lm
 CRI:Ra>90
 Beam Angle:15° /24° /36°
 Color:White/Black/Grey
 Material:Aluminium
 Size:138*H120mm
 Cutout:125mm
 Chips:Cree/Luminus/Citizen
 Driver:LiFud/PF>0.9
 Life span:30000 hours



灯具类型: 射灯 -KPETLNS30W
 电压: 220-240V/50Hz
 功率: 30W
 色温: 2700K/3000K/4000K/5000K
 光通量: 2850lm
 显色指数: Ra>90
 光束角: 15度 /24度 /36度
 颜色: 白 / 黑 / 灰
 材质: 压铸铝
 尺寸: 138*H120mm
 开孔: 125mm
 光源: 科锐 / 朗明纳斯 / 西铁城
 电源: 莱福德电源 /PF>0.9
 光源寿命: 30000 小时



光学配件 / OPTICAL ACCESSORIES

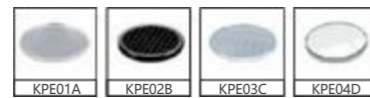

可选 / 不必要 / OPTIONAL / NOT NECESSARY
 KPE01A 柔光镜 soft lens
 KPE02B 蜂窝网 honeycomb
 KPE03C 拉伸镜 striation glass
 KPE04D 清玻片 Clear glass

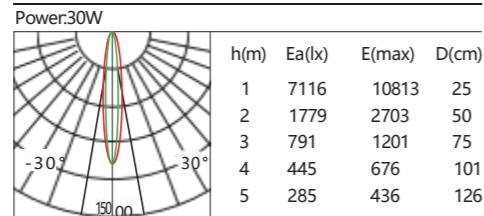

Beam Angle 15° Luminous flux(lm):1274 Imax(cd):10818



Type:Spotlight-KPETLNS40W
 Voltage:220-240V/50Hz
 Power:40W
 Color Temperature: 2700K/3000K/4000K/5000K
 Luminous Flux:3800lm
 CRI:Ra>90
 Beam Angle:15° /24° /36°
 Color:White/Black/Grey
 Material:Aluminium
 Size:165*H145mm
 Cutout:150mm
 Chips:Cree/Luminus/Citizen
 Driver:LiFud/PF>0.9
 Life span:30000 hours



灯具类型: 射灯 -KPETLNS40W
 电压: 220-240V/50Hz
 功率: 40W
 色温: 2700K/3000K/4000K/5000K
 光通量: 3800lm
 显色指数: Ra>90
 光束角: 15度 /24度 /36度
 颜色: 白 / 黑 / 灰
 材质: 压铸铝
 尺寸: 165*H145mm
 开孔: 150mm
 光源: 科锐 / 朗明纳斯 / 西铁城
 电源: 莱福德电源 /PF>0.9
 光源寿命: 30000 小时



光学配件 / OPTICAL ACCESSORIES



可选 / 不必要 / OPTIONAL / NOT NECESSARY
 KPE01A 柔光镜 soft lens
 KPE02B 蜂窝网 honeycomb
 KPE03C 拉伸镜 striation glass
 KPE04D 清玻片 Clear glass

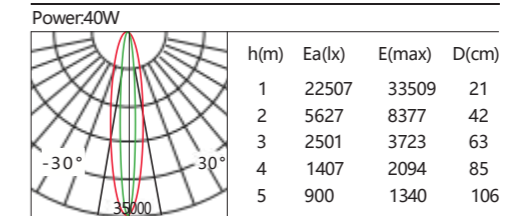

Beam Angle 15° Luminous flux(lm):2667 Imax(cd):33524



Type:Spotlight-KPETLNS50W
 Voltage:220-240V/50Hz
 Power:50W
 Color Temperature: 2700K/3000K/4000K/5000K
 Luminous Flux:4650lm
 CRI:Ra>90
 Beam Angle:15° /24° /36°
 Color:White/Black/Grey
 Material:Aluminium
 Size:190*H165mm
 Cutout:175mm
 Chips:Cree/Luminus/Citizen
 Driver:LiFud/PF>0.9
 Life span:30000 hours



灯具类型: 射灯 -KPETLNS50W
 电压: 220-240V/50Hz
 功率: 50W
 色温: 2700K/3000K/4000K/5000K
 光通量: 4650lm
 显色指数: Ra>90
 光束角: 15度/24度/36度
 颜色: 白/黑/灰
 材质: 压铸铝
 尺寸: 190*H165mm
 开孔: 175mm
 光源: 科锐/朗明纳斯/西铁城
 电源: 莱福德电源/PF>0.9
 光源寿命: 30000小时



光学配件 / OPTICAL ACCESSORIES

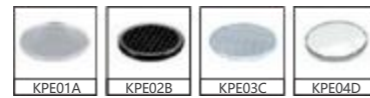

可选 / 不必要 / OPTIONAL / NOT NECESSARY
 KPE01A 柔光镜 soft lens
 KPE02B 蜂窝网 honeycomb
 KPE03C 拉伸镜 striation glass
 KPE04D 清玻片 Clear glass

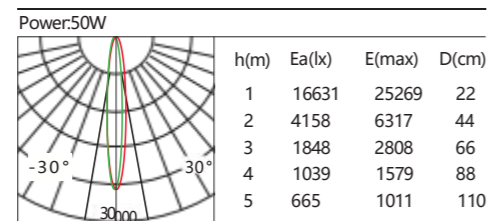

Beam Angle 15° Luminous flux(lm):1890 I_{max}(cd):23280



Type:Spotlight-KPETLNS12W / KPETLNS25W / KPETLNS35W
 Voltage:220-240V/50Hz
 Power:12W/25W/35W
 Color Temperature: 2700K/3000K/4000K/5000K
 Luminous Flux:1100lm/2400lm/3300lm
 CRI:Ra>90
 Beam Angle:15° /24° /36°
 Color:White/Black/Grey
 Material:Aluminium
 Size:115*115mm/138*138mm/163*163mm
 Cutout:100*100mm/125*125mm/150*150mm
 Chips:Cree/Luminus/Citizen
 Driver:LiFud/PF>0.9
 Life span:30000 hours



灯具类型: 射灯 -KPETLNS12W / KPETLNS25W / KPETLNS35W
 电压: 220-240V/50Hz
 功率: 12W/25W/35W
 色温: 2700K/3000K/4000K/5000K
 光通量: 1100lm/2400lm/3300lm
 显色指数: Ra>90
 光束角: 15度/24度/36度
 颜色: 白/黑/灰
 材质: 压铸铝
 尺寸: 115*115mm/138*138mm/163*163mm
 开孔: 100*100mm/125*125mm/150*150mm
 光源: 科锐/朗明纳斯/西铁城
 电源: 莱福德电源/PF>0.9
 光源寿命: 30000小时



光学配件 / OPTICAL ACCESSORIES



可选 / 不必要 / OPTIONAL / NOT NECESSARY
 KPE01A 柔光镜 soft lens
 KPE02B 蜂窝网 honeycomb
 KPE03C 拉伸镜 striation glass
 KPE04D 清玻片 Clear glass

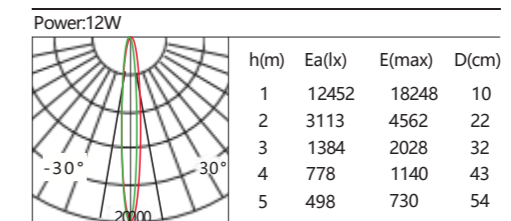

Beam Angle 15° Luminous flux(lm):415 I_{max}(cd):18248



Type:Spotlight-KPETLNS12W*2 / KPETLNS25W*2 / KPETLNS35W*2
 Voltage:220-240V/50Hz
 Power:12W*2/25W*2/35W*2
 Color Temperature: 2700K/3000K/4000K/5000K
 Luminous Flux:2200lm/4800lm/6600lm
 CRI:Ra>90
 Beam Angle:15° /24° /36°
 Color:White/Black/Grey
 Material:Aluminium
 Size:230*115mm/278*138mm/330*163mm
 Cutout:215*100mm/263*125mm/315*150mm
 Chips:Cree/Luminus/Citizen
 Driver:LiFud/PF>0.9
 Life span:30000 hours

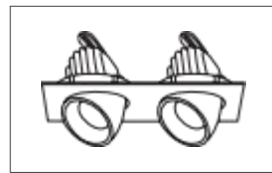

灯具类型: 射灯 -KPETLNS12W*2 / KPETLNS25W*2 / KPETLNS35W*2
 电压: 220-240V/50Hz
 功率: 12W*2/25W*2/35W*2
 色温: 2700K/3000K/4000K/5000K
 光通量: 2200lm/4800lm/6600lm
 显色指数: Ra>90
 光束角: 15度 /24度 /36度
 颜色: 白 / 黑 / 灰
 材质: 压铸铝
 尺寸: 230*115mm/278*138mm/330*163mm
 开孔: 215*100mm/263*125mm/315*150mm
 光源: 科锐 / 朗明纳斯 / 西铁城
 电源: 莱福德电源 /PF>0.9
 光源寿命: 30000 小时



光学配件 / OPTICAL ACCESSORIES

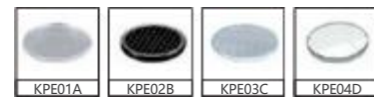

可选 / 不必要 / OPTIONAL / NOT NECESSARY
 KPE01A 柔光镜 soft lens
 KPE02B 蜂窝网 honeycomb
 KPE03C 拉伸镜 striation glass
 KPE04D 清玻片 Clear glass

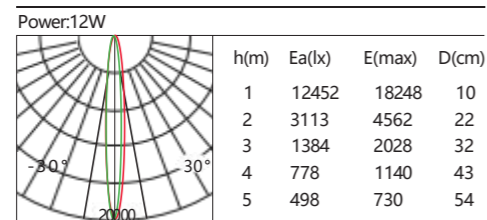

Beam Angle 15° Luminous flux(lm):415 I_{max}(cd):18248



Type:Spotlight-KPETLNS12W*3 / KPETLNS25W*3 / KPETLNS35W*3
 Voltage:220-240V/50Hz
 Power:12W*3/25W*3/35W*3
 Color Temperature: 2700K/3000K/4000K/5000K
 Luminous Flux:3300lm/7200lm/9900lm
 CRI:Ra>90
 Beam Angle:15° /24° /36°
 Color:White/Black/Grey
 Material:Aluminium
 Size:350*115mm/417*138mm/495*163mm
 Cutout:335*100mm/400*125mm/480*150mm
 Chips:Cree/Luminus/Citizen
 Driver:LiFud/PF>0.9
 Life span:30000 hours

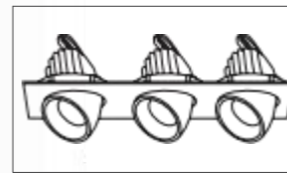

灯具类型: 射灯 -KPETLNS12W*3 / KPETLNS25W*3 / KPETLNS35W*3
 电压: 220-240V/50Hz
 功率: 12W*3/25W*3/35W*3
 色温: 2700K/3000K/4000K/5000K
 光通量: 3300lm/7200lm/9900lm
 显色指数: Ra>90
 光束角: 15度 /24度 /36度
 颜色: 白 / 黑 / 灰
 材质: 压铸铝
 尺寸: 350*115mm/417*138mm/495*163mm
 开孔: 335*100mm/400*125mm/480*150mm
 光源: 科锐 / 朗明纳斯 / 西铁城
 电源: 莱福德电源 /PF>0.9
 光源寿命: 30000 小时



光学配件 / OPTICAL ACCESSORIES



可选 / 不必要 / OPTIONAL / NOT NECESSARY
 KPE01A 柔光镜 soft lens
 KPE02B 蜂窝网 honeycomb
 KPE03C 拉伸镜 striation glass
 KPE04D 清玻片 Clear glass

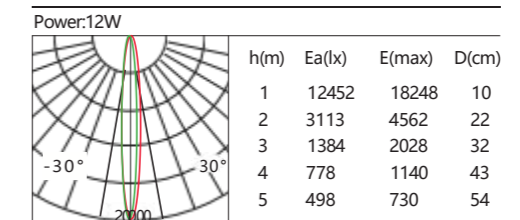

Beam Angle 15° Luminous flux(lm):415 I_{max}(cd):18248



LED Downlight—Aimer Series
LED 筒灯—埃玛系列

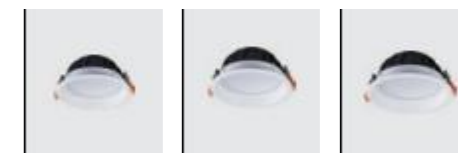

KPEDLAS7W

KPEDLAS10W

KPEDLAS18W

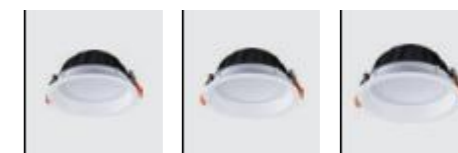

KPEDLAS24W

KPEDLAS30W

KPEDLAS35W

LED
DOWNLIGHT
Aimer Series

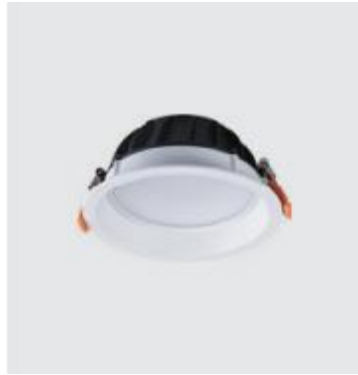

Type:Downlight-KPEDLAS7W
 Voltage:220-240V/50Hz
 Power:7W
 Color Temperature: 2700K/3000K/4000K/5000K
 Luminous Flux:600lm
 CRI:Ra>90
 Beam Angle:120°
 Color:White+Black
 Material:Aluminium
 Size:110*H60mm
 Cutout:100mm
 Chips:Sanan
 Driver:LiFud/PF>0.9
 Life span:30000 hours

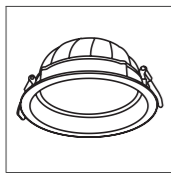

灯具类型: 筒灯 -KPEDLAS7W
 电压: 220-240V/50Hz
 功率: 7W
 色温: 2700K/3000K/4000K/5000K
 光通量: 600lm
 显色指数: Ra>90
 光束角: 120 度
 颜色: 白 + 黑
 材质: 压铸铝
 尺寸: 110*60mm
 开孔: 100mm
 光源: 三安
 电源: 莱福德电源 /PF>0.9
 光源寿命: 30000 小时



Power:7W

h(m)	Ea(lx)	E(max)
1	108.4	195.18
2	27.11	390.37
3	12.05	585.55
4	6.777	780.73
5	4.337	975.92

Beam Angle 120°



Type:Downlight-KPEDLAS10W
 Voltage:220-240V/50Hz
 Power:10W
 Color Temperature: 2700K/3000K/4000K/5000K
 Luminous Flux:900lm
 CRI:Ra>90
 Beam Angle:120°
 Color:White+Black
 Material:Aluminium
 Size:140*H70mm
 Cutout:130mm
 Chips:Sanan
 Driver:LiFud/PF>0.9
 Life span:30000 hours

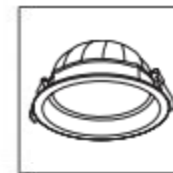

灯具类型: 筒灯 -KPEDLAS10W
 电压: 220-240V/50Hz
 功率: 10W
 色温: 2700K/3000K/4000K/5000K
 光通量: 900lm
 显色指数: Ra>90
 光束角: 120 度
 颜色: 白 + 黑
 材质: 压铸铝
 尺寸: 140*70mm
 开孔: 130mm
 光源: 三安
 电源: 莱福德电源 /PF>0.9
 光源寿命: 30000 小时

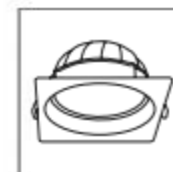

Power:10W

h(m)	Ea(lx)	E(max)
1	118.5	241.72
2	29.61	483.44
3	13.16	725.16
4	7.404	966.88
5	4.738	1208.60

Beam Angle 120°



Type:Downlight-KPEDLAS18W
 Voltage:220-240V/50Hz
 Power:18W
 Color Temperature: 2700K/3000K/4000K/5000K
 Luminous Flux:1700lm
 CRI:Ra>90
 Beam Angle:120°
 Color:White+Black
 Material:Aluminium
 Size:170*H75mm
 Cutout:160mm
 Chips:Sanan
 Driver:LiFud/PF>0.9
 Life span:30000 hours

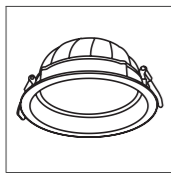

灯具类型: 筒灯 -KPEDLAS18W
 电压: 220-240V/50Hz
 功率: 18W
 色温: 2700K/3000K/4000K/5000K
 光通量: 1700lm
 显色指数: Ra>90
 光束角: 120 度
 颜色: 白 + 黑
 材质: 压铸铝
 尺寸: 170*75mm
 开孔: 160mm
 光源: 三安
 电源: 莱福德电源 /PF>0.9
 光源寿命: 30000 小时

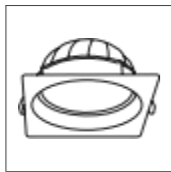

Power:18W

h(m)	Ea(lx)	E(max)
1	160.3	201.94
2	40.09	403.88
3	17.82	605.82
4	10.02	807.76
5	6.414	1009.7

Beam Angle 120°



Type:Downlight-KPEDLAS24W
 Voltage:220-240V/50Hz
 Power:24W
 Color Temperature: 2700K/3000K/4000K/5000K
 Luminous Flux:2250lm
 CRI:Ra>90
 Beam Angle:120°
 Color:White+Black
 Material:Aluminium
 Size:190*H80mm
 Cutout:175mm
 Chips:Sanan
 Driver:LiFud/PF>0.9
 Life span:30000 hours

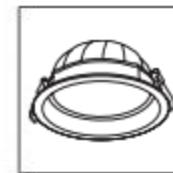

灯具类型: 筒灯 -KPEDLAS24W
 电压: 220-240V/50Hz
 功率: 24W
 色温: 2700K/3000K/4000K/5000K
 光通量: 2250lm
 显色指数: Ra>90
 光束角: 120 度
 颜色: 白 + 黑
 材质: 压铸铝
 尺寸: 190*80mm
 开孔: 175mm
 光源: 三安
 电源: 莱福德电源 /PF>0.9
 光源寿命: 30000 小时

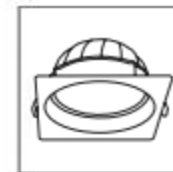

Power:24W

h(m)	Ea(lx)	E(max)
1	250.3	196.21
2	62.83	392.42
3	27.92	588.62
4	15.71	784.83
5	10.05	981.04

Beam Angle 120°



Type:Downlight-KPEDLAS30W
 Voltage:220-240V/50Hz
 Power:30W
 Color Temperature: 2700K/3000K/4000K/5000K
 Luminous Flux:2800lm
 CRI:Ra>90
 Beam Angle:120°
 Color:White+Black
 Material:Aluminium
 Size:230*H85mm
 Cutout:210mm
 Chips:Sanan
 Driver:LiFud/PF>0.9
 Life span:30000 hours

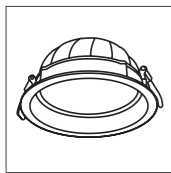

灯具类型: 筒灯 -KPEDLAS30W
 电压: 220-240V/50Hz
 功率: 30W
 色温: 2700K/3000K/4000K/5000K
 光通量: 2800lm
 显色指数: Ra>90
 光束角: 120 度
 颜色: 白 + 黑
 材质: 压铸铝
 尺寸: 230*85mm
 开孔: 210mm
 光源: 三安
 电源: 莱福德电源 /PF>0.9
 光源寿命: 30000 小时

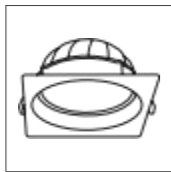

Power:30W

h(m)	Ea(lx)	E(max)
1	179.2	294.69
2	44.81	588.69
3	19.91	883.03
4	11.20	1177.37
5	7.169	1471.72

Beam Angle 120°



Type:Downlight-KPEDLAS35W
 Voltage:220-240V/50Hz
 Power:35W
 Color Temperature: 2700K/3000K/4000K/5000K
 Luminous Flux:3300lm
 CRI:Ra>90
 Beam Angle:120°
 Color:White+Black
 Material:Aluminium
 Size:260*H90mm
 Cutout:240mm
 Chips:Sanan
 Driver:LiFud/PF>0.9
 Life span:30000 hours

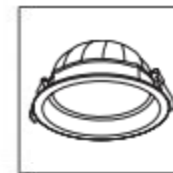

灯具类型: 筒灯 -KPEDLAS35W
 电压: 220-240V/50Hz
 功率: 35W
 色温: 2700K/3000K/4000K/5000K
 光通量: 3300lm
 显色指数: Ra>90
 光束角: 120 度
 颜色: 白 + 黑
 材质: 压铸铝
 尺寸: 260*90mm
 开孔: 240mm
 光源: 三安
 电源: 莱福德电源 /PF>0.9
 光源寿命: 30000 小时

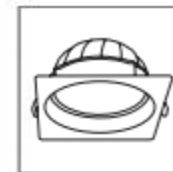

Power:35W

h(m)	Ea(lx)	E(max)
1	227.9	294.07
2	56.96	588.13
3	25.32	882.20
4	14.24	1176.27
5	9.114	1470.34

Beam Angle 120°

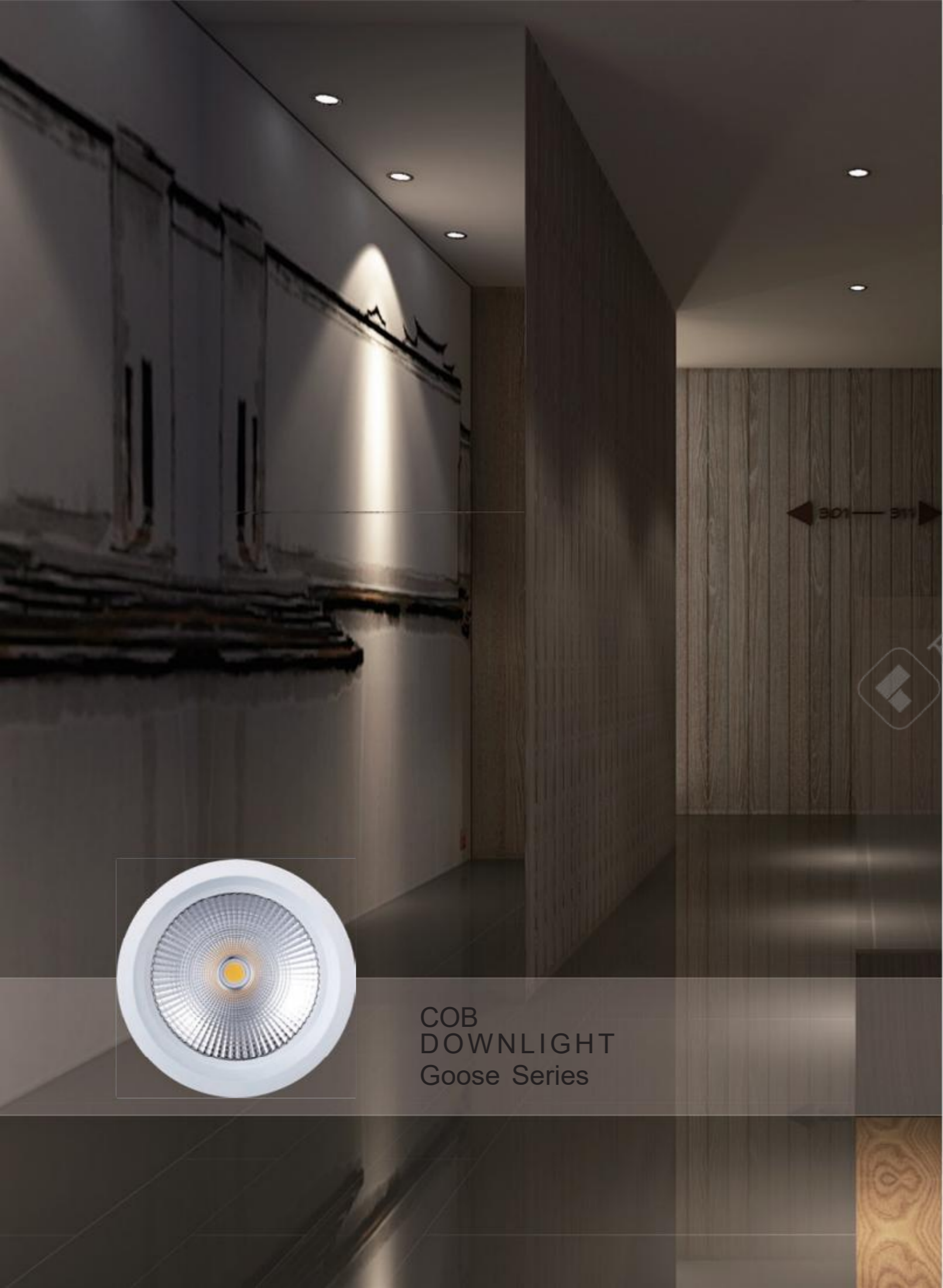

COB
DOWNLIGHT
Goose Series

COB Downlight—Goose Series
COB 筒灯—库思系列

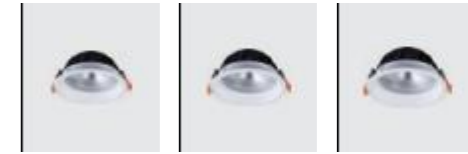

KPECDLGS7W

KPECDLGS10W

KPECDLGS18W

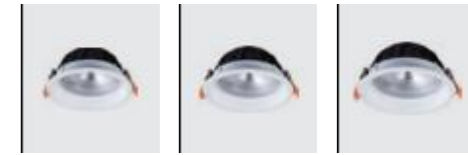

KPECDLGS24W

KPECDLGS30W

KPECDLGS35W

PDF



Type:Downlight-KPECDLGS7W
 Voltage:220-240V/50Hz
 Power:7W
 Color Temperature: 2700K/3000K/4000K/5000K
 Luminous Flux:600lm
 CRI:Ra>90
 Beam Angle:120°
 Color:White+Black
 Material:Aluminium
 Size:110*H60mm
 Cutout:100mm
 Chips:Cree/Luminus/Citizen
 Driver:LiFud/PF>0.9
 Life span:30000 hours

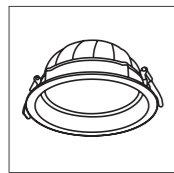

灯具类型:筒灯-KPECDLGS7W
 电压:220-240V/50Hz
 功率:7W
 色温:2700K/3000K/4000K/5000K
 光通量:600lm
 显色指数:Ra>90
 光束角:120度
 颜色:白+黑
 材质:压铸铝
 尺寸:110*60mm
 开孔:100mm
 光源:科锐/朗明纳斯/西铁城
 电源:莱福德电源/PF>0.9
 光源寿命:30000小时

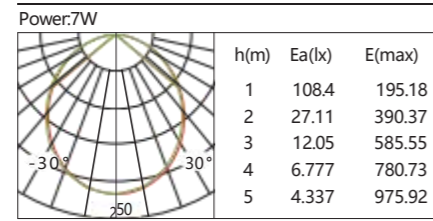
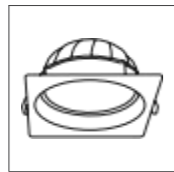

Beam Angle 120°

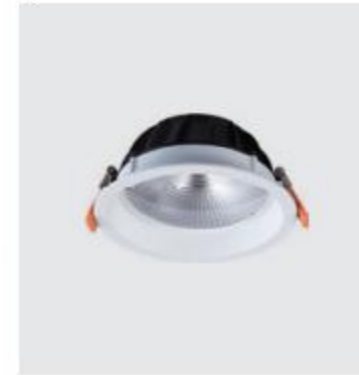

Type:Downlight-KPECDLGS10W
 Voltage:220-240V/50Hz
 Power:10W
 Color Temperature: 2700K/3000K/4000K/5000K
 Luminous Flux:900lm
 CRI:Ra>90
 Beam Angle:120°
 Color:White+Black
 Material:Aluminium
 Size:140*H70mm
 Cutout:130mm
 Chips:Cree/Luminus/Citizen
 Driver:LiFud/PF>0.9
 Life span:30000 hours

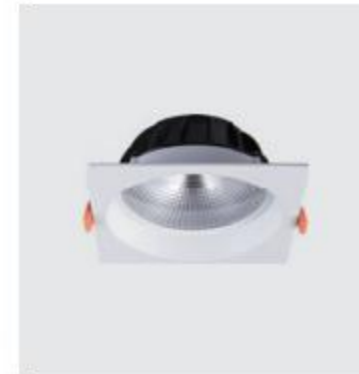

灯具类型:筒灯-KPECDLGS10W
 电压:220-240V/50Hz
 功率:10W
 色温:2700K/3000K/4000K/5000K
 光通量:900lm
 显色指数:Ra>90
 光束角:120度
 颜色:白+黑
 材质:压铸铝
 尺寸:140*70mm
 开孔:130mm
 光源:科锐/朗明纳斯/西铁城
 电源:莱福德电源/PF>0.9
 光源寿命:30000小时

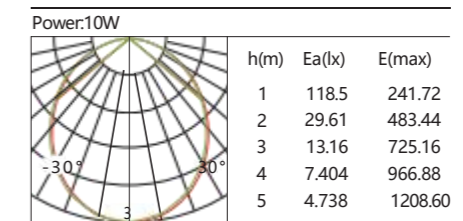
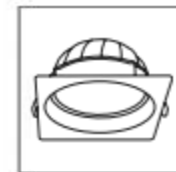

Beam Angle 120°

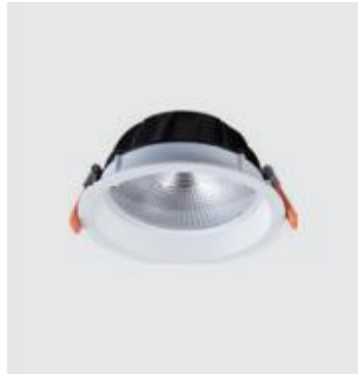

Type:Downlight-KPECDLGS18W
 Voltage:220-240V/50Hz
 Power:18W
 Color Temperature: 2700K/3000K/4000K/5000K
 Luminous Flux:1700lm
 CRI:Ra>90
 Beam Angle:120°
 Color:White+Black
 Material:Aluminium
 Size:170*H75mm
 Cutout:160mm
 Chips:Cree/Luminus/Citizen
 Driver:LiFud/PF>0.9
 Life span:30000 hours

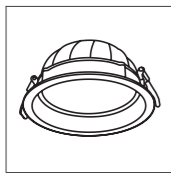

灯具类型: 筒灯 -KPECDLGS18W
 电压: 220-240V/50Hz
 功率: 18W
 色温: 2700K/3000K/4000K/5000K
 光通量: 1700lm
 显色指数: Ra>90
 光束角: 120 度
 颜色: 白 + 黑
 材质: 压铸铝
 尺寸: 170*75mm
 开孔: 160mm
 光源: 科锐 / 朗明纳斯 / 西铁城
 电源: 莱福德电源 /PF>0.9
 光源寿命: 30000 小时

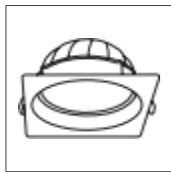

Power:18W

h(m)	Ea(lx)	E(max)
1	160.3	201.94
2	40.09	403.88
3	17.82	605.82
4	10.02	807.76
5	6.414	1009.7

Beam Angle 120°

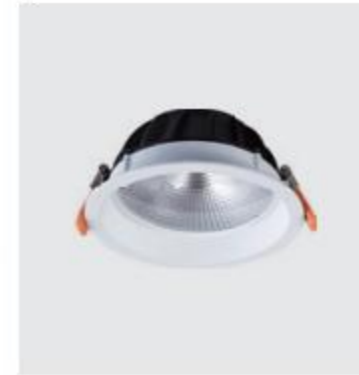

Type:Downlight-KPECDLGS24W
 Voltage:220-240V/50Hz
 Power:24W
 Color Temperature: 2700K/3000K/4000K/5000K
 Luminous Flux:2250lm
 CRI:Ra>90
 Beam Angle:120°
 Color:White+Black
 Material:Aluminium
 Size:190*H80mm
 Cutout:175mm
 Chips:Cree/Luminus/Citizen
 Driver:LiFud/PF>0.9
 Life span:30000 hours

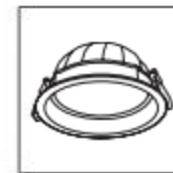

灯具类型: 筒灯 -KPECDLGS24W
 电压: 220-240V/50Hz
 功率: 24W
 色温: 2700K/3000K/4000K/5000K
 光通量: 2250lm
 显色指数: Ra>90
 光束角: 120 度
 颜色: 白 + 黑
 材质: 压铸铝
 尺寸: 190*80mm
 开孔: 175mm
 光源: 科锐 / 朗明纳斯 / 西铁城
 电源: 莱福德电源 /PF>0.9
 光源寿命: 30000 小时

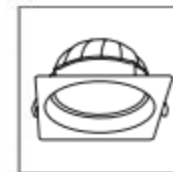

Power:24W

h(m)	Ea(lx)	E(max)
1	250.3	196.21
2	62.83	392.42
3	27.92	588.62
4	15.71	784.83
5	10.05	981.04

Beam Angle 120°

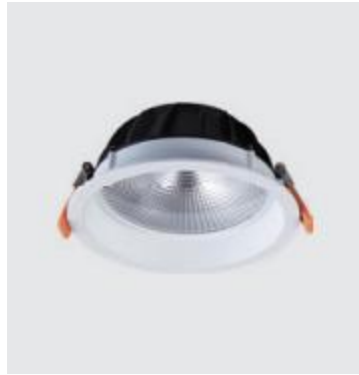

Type:Downlight-KPECDLGS30W
 Voltage:220-240V/50Hz
 Power:30W
 Color Temperature: 2700K/3000K/4000K/5000K
 Luminous Flux:2800lm
 CRI:Ra>90
 Beam Angle:120°
 Color:White+Black
 Material:Aluminium
 Size:230*H85mm
 Cutout:210mm
 Chips:Cree/Luminus/Citizen
 Driver:LiFud/PF>0.9
 Life span:30000 hours

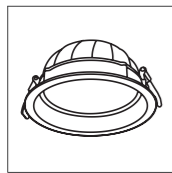

灯具类型:筒灯-KPECDLGS30W
 电压:220-240V/50Hz
 功率:30W
 色温:2700K/3000K/4000K/5000K
 光通量:2800lm
 显色指数:Ra>90
 光束角:120度
 颜色:白+黑
 材质:压铸铝
 尺寸:230*85mm
 开孔:210mm
 光源:科锐/朗明纳斯/西铁城
 电源:莱福德电源/PF>0.9
 光源寿命:30000小时

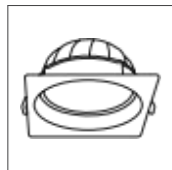

Power:30W

h(m)	Ea(lx)	E(max)
1	179.2	294.69
2	44.81	588.69
3	19.91	883.03
4	11.20	1177.37
5	7.169	1471.72

Beam Angle 120°



Type:Downlight-KPECDLGS35W
 Voltage:220-240V/50Hz
 Power:35W
 Color Temperature: 2700K/3000K/4000K/5000K
 Luminous Flux:3300lm
 CRI:Ra>90
 Beam Angle:120°
 Color:White+Black
 Material:Aluminium
 Size:260*H90mm
 Cutout:240mm
 Chips:Cree/Luminus/Citizen
 Driver:LiFud/PF>0.9
 Life span:30000 hours

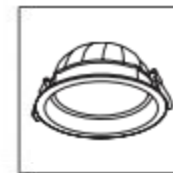

灯具类型:筒灯-KPECDLGS35W
 电压:220-240V/50Hz
 功率:35W
 色温:2700K/3000K/4000K/5000K
 光通量:3300lm
 显色指数:Ra>90
 光束角:120度
 颜色:白+黑
 材质:压铸铝
 尺寸:260*90mm
 开孔:240mm
 光源:科锐/朗明纳斯/西铁城
 电源:莱福德电源/PF>0.9
 光源寿命:30000小时

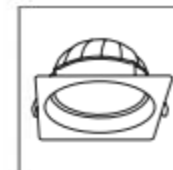

Power:35W

h(m)	Ea(lx)	E(max)
1	227.9	294.07
2	56.96	588.13
3	25.32	882.20
4	14.24	1176.27
5	9.114	1470.34

Beam Angle 120°



COB
MOUNTED DOWNLIGHT
Kaer Series

COB Mounted Downlight—Kaer Series
COB 明装筒灯——卡尔系列



KPECMDLKS9W

KPECMDLKS15W

KPECMDLKS24W

KPECMDLKS36W

KPECMDLKS45W

Mounted Downlight 明装筒灯：

Copper surface mounted lamps,high purity aluminium reflector,light more evenly and effectively improve the utilization of smallpox.Copper surface mounted light in open space,the height of the large,high-ceiling space spaces;neatly arranged,that plays lighting ,landscaping effects of smallpox,and by the light play a role in the guidelines.

明装筒灯，高纯铝反射器，发光更均匀，有效提高天花的使用率。明装筒灯应用在空间开阔，高度较大，高天花空间场所；整齐排列，即起到照明，美好天花的作用，而且通过灯光起到一定的指引作用。



Type: Mounted Downlight-KPECMDLKS9W
 Voltage: 220-240V/50Hz
 Power: 9W
 Color Temperature: 2700K/3000K/4000K/5000K
 Luminous Flux: 800lm
 CRI: Ra>90
 Beam Angle: 120°
 Color: White+Black
 Material: Aluminium
 Size: 90*H90mm
 Chips: Cree/Luminus/Citizen
 Driver: LiFud/PF>0.9
 Life span: 30000 hours

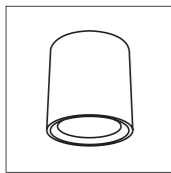

灯具类型: 明装筒灯 -KPECMDLKS9W
 电压: 220-240V/50Hz
 功率: 9W
 色温: 2700K/3000K/4000K/5000K
 光通量: 800lm
 显色指数: Ra>90
 光束角: 120度
 颜色: 白+黑
 材质: 压铸铝
 尺寸: 90*90mm
 光源: 科锐/朗明纳斯/西铁城
 电源: 莱福德电源/PF>0.9
 光源寿命: 30000小时

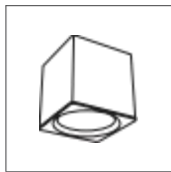

Power: 9W

h(m)	Ea(lx)	E(max)
1	108.4	195.18
2	27.11	390.37
3	12.05	585.55
4	6.777	780.73
5	4.337	975.92

Beam Angle 120°

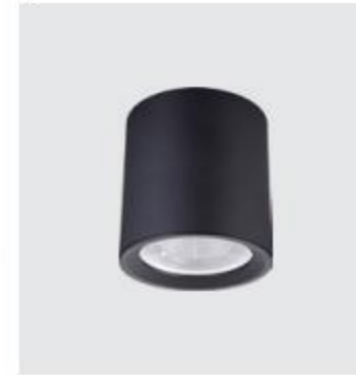

Type: Mounted Downlight-KPECMDLKS15W
 Voltage: 220-240V/50Hz
 Power: 15W
 Color Temperature: 2700K/3000K/4000K/5000K
 Luminous Flux: 1400lm
 CRI: Ra>90
 Beam Angle: 120°
 Color: White+Black
 Material: Aluminium
 Size: 110*H120mm
 Chips: Cree/Luminus/Citizen
 Driver: LiFud/PF>0.9
 Life span: 30000 hours

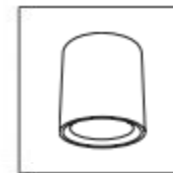

灯具类型: 明装筒灯 -KPECMDLKS15W
 电压: 220-240V/50Hz
 功率: 15W
 色温: 2700K/3000K/4000K/5000K
 光通量: 1400lm
 显色指数: Ra>90
 光束角: 120度
 颜色: 白+黑
 材质: 压铸铝
 尺寸: 110*120mm
 光源: 科锐/朗明纳斯/西铁城
 电源: 莱福德电源/PF>0.9
 光源寿命: 30000小时



Power: 15W

h(m)	Ea(lx)	E(max)
1	118.5	241.72
2	29.61	483.44
3	13.16	725.16
4	7.404	966.88
5	4.738	1208.60

Beam Angle 120°



Type: Mounted Downlight-KPECMDLKS24W
 Voltage: 220-240V/50Hz
 Power: 24W
 Color Temperature: 2700K/3000K/4000K/5000K
 Luminous Flux: 2250lm
 CRI: Ra>90
 Beam Angle: 120°
 Color: White+Black
 Material: Aluminium
 Size: 132*H155mm
 Chips: Cree/Luminus/Citizen
 Driver: LiFud/PF>0.9
 Life span: 30000 hours

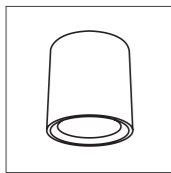

灯具类型: 明装筒灯 -KPECMDLKS24W
 电压: 220-240V/50Hz
 功率: 24W
 色温: 2700K/3000K/4000K/5000K
 光通量: 2250lm
 显色指数: Ra>90
 光束角: 120度
 颜色: 白+黑
 材质: 压铸铝
 尺寸: 132*155mm
 光源: 科锐/朗明纳斯/西铁城
 电源: 莱福德电源/PF>0.9
 光源寿命: 30000小时

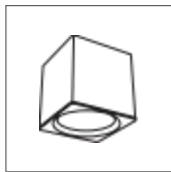

Power: 24W

h(m)	Ea(lx)	E(max)
1	160.3	201.94
2	40.09	403.88
3	17.82	605.82
4	10.02	807.76
5	6.414	1009.7

Beam Angle 120°

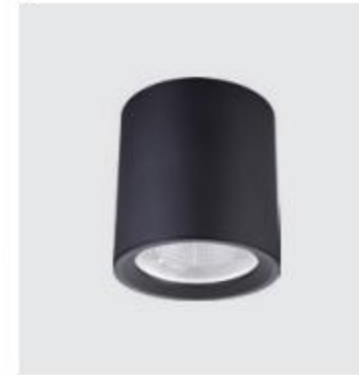

Type: Mounted Downlight-KPECMDLKS36W
 Voltage: 220-240V/50Hz
 Power: 36W
 Color Temperature: 2700K/3000K/4000K/5000K
 Luminous Flux: 3400lm
 CRI: Ra>90
 Beam Angle: 120°
 Color: White+Black
 Material: Aluminium
 Size: 170*H192mm
 Chips: Cree/Luminus/Citizen
 Driver: LiFud/PF>0.9
 Life span: 30000 hours

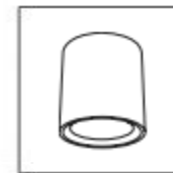

灯具类型: 明装筒灯 -KPECMDLKS36W
 电压: 220-240V/50Hz
 功率: 36W
 色温: 2700K/3000K/4000K/5000K
 光通量: 3400lm
 显色指数: Ra>90
 光束角: 120度
 颜色: 白+黑
 材质: 压铸铝
 尺寸: 170*192mm
 光源: 科锐/朗明纳斯/西铁城
 电源: 莱福德电源/PF>0.9
 光源寿命: 30000小时



Power: 36W

h(m)	Ea(lx)	E(max)
1	250.3	196.21
2	62.83	392.42
3	27.92	588.62
4	15.71	784.83
5	10.05	981.04

Beam Angle 120°

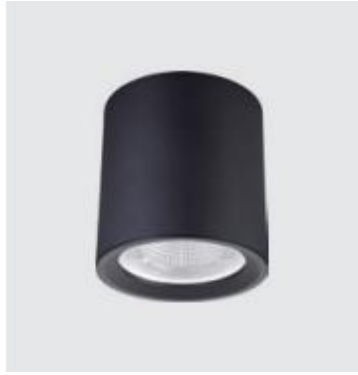

Type: Mounted Downlight-KPECMDLKS45W
 Voltage: 220-240V/50Hz
 Power: 45W
 Color Temperature: 2700K/3000K/4000K/5000K
 Luminous Flux: 4300lm
 CRI: Ra > 90
 Beam Angle: 120°
 Color: White+Black
 Material: Aluminium
 Size: 195*H200mm
 Chips: Cree/Luminus/Citizen
 Driver: LiFud/PF > 0.9
 Life span: 30000 hours

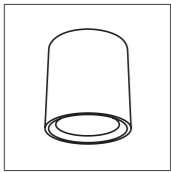

灯具类型: 明装筒灯 -KPECMDLKS45W
 电压: 220-240V/50Hz
 功率: 45W
 色温: 2700K/3000K/4000K/5000K
 光通量: 4300lm
 显色指数: Ra > 90
 光束角: 120度
 颜色: 白 + 黑
 材质: 压铸铝
 尺寸: 195*200mm
 光源: 科锐 / 朗明纳斯 / 西铁城
 电源: 莱福德电源 / PF > 0.9
 光源寿命: 30000 小时



Power: 45W

h(m)	Ea(lx)	E(max)
1	179.2	294.69
2	44.81	588.69
3	19.91	883.03
4	11.20	1177.37
5	7.169	1471.72

Beam Angle 120°

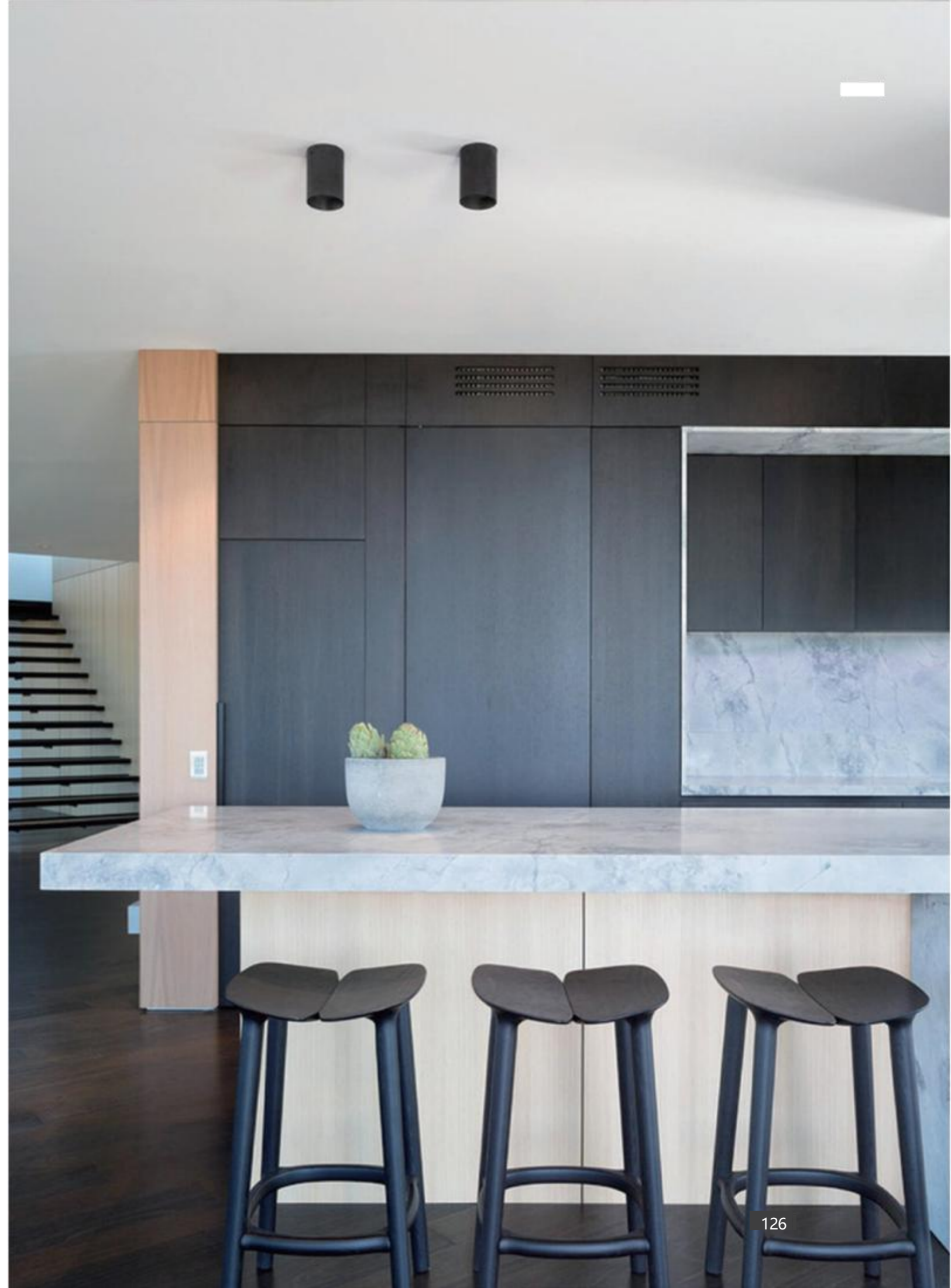



LED
CEILING LIGHT
Rhyme Series

LED Ceiling Light—Rhyme Series
LED 天花射灯—韵系列



KPECLRS10W



KPECLRS15W



KPECLRS25W



KPECLRS35W



Type:Spotlight-KPECLRS10W
 Voltage:220-240V/50Hz
 Power:10W
 Color Temperature: 2700K/3000K/4000K/5000K
 Luminous Flux:900lm
 CRI:Ra>90
 Beam Angle:15° /24°
 Color:White+Black+Grey
 Material:Aluminium
 Size:87*78mm
 Cutout:75mm
 Chips:Cree/Luminus/Citizen
 Driver:LiFud/PF>0.9
 Life span:30000 hours

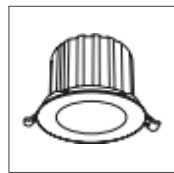

灯具类型: 射灯 -KPECLRS10W
 电压: 220-240V/50Hz
 功率: 10W
 色温: 2700K/3000K/4000K/5000K
 光通量: 900lm
 显色指数: Ra>90
 光束角: 15度 /24度
 颜色: 白+黑+灰
 材质: 铝材质
 尺寸: 87*78mm
 开孔: 75mm
 光源: 科锐 / 朗明纳斯 / 西铁城
 电源: 莱福德电源 /PF>0.9
 光源寿命: 30000 小时



光学配件 / OPTICAL ACCESSORIES

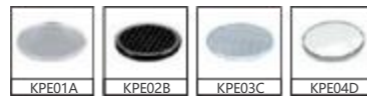

可选 / 不必要 / OPTIONAL / NOT NECESSARY
 KPE01A 柔光镜 soft lens
 KPE02B 蜂窝网 honeycomb
 KPE03C 拉伸镜 striation glass
 KPE04D 清玻片 Clear glass

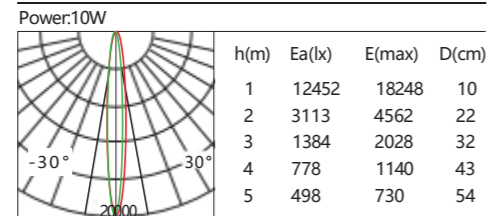

Beam Angle 15° Luminous flux(lm):415 I_{max}(cd):18248



Type:Spotlight-KPECLRS15W
 Voltage:220-240V/50Hz
 Power:15W
 Color Temperature: 2700K/3000K/4000K/5000K
 Luminous Flux:1350lm
 CRI:Ra>90
 Beam Angle:15° /24°
 Color:White+Black+Grey
 Material:Aluminium
 Size:110*90mm
 Cutout:90mm
 Chips:Cree/Luminus/Citizen
 Driver:LiFud/PF>0.9
 Life span:30000 hours

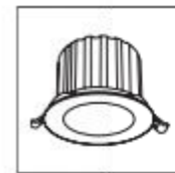

灯具类型: 射灯 -KPECLRS15W
 电压: 220-240V/50Hz
 功率: 15W
 色温: 2700K/3000K/4000K/5000K
 光通量: 1350lm
 显色指数: Ra>90
 光束角: 15度 /24度
 颜色: 白+黑+灰
 材质: 铝材质
 尺寸: 110*90mm
 开孔: 90mm
 光源: 科锐 / 朗明纳斯 / 西铁城
 电源: 莱福德电源 /PF>0.9
 光源寿命: 30000 小时



光学配件 / OPTICAL ACCESSORIES



可选 / 不必要 / OPTIONAL / NOT NECESSARY
 KPE01A 柔光镜 soft lens
 KPE02B 蜂窝网 honeycomb
 KPE03C 拉伸镜 striation glass
 KPE04D 清玻片 Clear glass

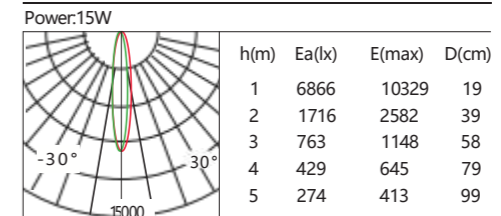

Beam Angle 15° Luminous flux(lm):638 I_{max}(cd):10329



Type:Spotlight-KPECLRS25W
 Voltage:220-240V/50Hz
 Power:25W
 Color Temperature: 2700K/3000K/4000K/5000K
 Luminous Flux:2300lm
 CRI:Ra>90
 Beam Angle:15° /24°
 Color:White+Black+Grey
 Material:Aluminium
 Size:138*100mm
 Cutout:120mm
 Chips:Cree/Luminus/Citizen
 Driver:LiFud/PF>0.9
 Life span:30000 hours

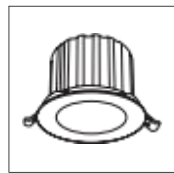

灯具类型: 射灯 -KPECLRS25W
 电压: 220-240V/50Hz
 功率: 25W
 色温: 2700K/3000K/4000K/5000K
 光通量: 2300lm
 显色指数: Ra>90
 光束角: 15度 /24度
 颜色: 白+黑+灰
 材质: 铝材质
 尺寸: 138*100mm
 开孔: 120mm
 光源: 科锐 / 朗明纳斯 / 西铁城
 电源: 莱福德电源 /PF>0.9
 光源寿命: 30000 小时



光学配件 / OPTICAL ACCESSORIES

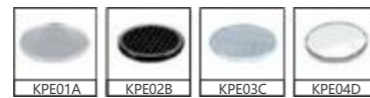

可选 / 不必要 / OPTIONAL / NOT NECESSARY
 KPE01A 柔光镜 soft lens
 KPE02B 蜂窝网 honeycomb
 KPE03C 拉伸镜 striation glass
 KPE04D 清玻片 Clear glass

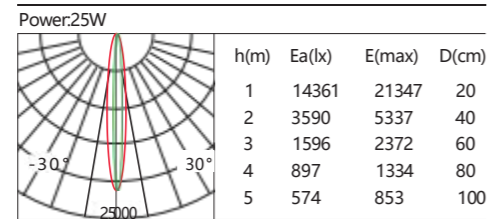

Beam Angle 15° Luminous flux(lm):1345 I_{max}(cd):21347

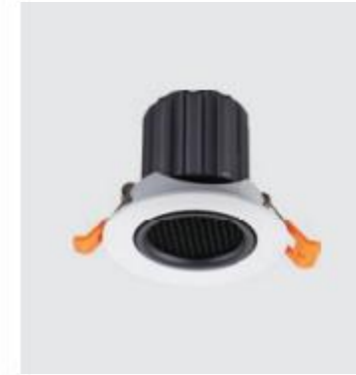

Type:Spotlight-KPECLRS35W
 Voltage:220-240V/50Hz
 Power:35W
 Color Temperature: 2700K/3000K/4000K/5000K
 Luminous Flux:3300lm
 CRI:Ra>90
 Beam Angle:15° /24°
 Color:White+Black+Grey
 Material:Aluminium
 Size:160*105mm
 Cutout:150mm
 Chips:Cree/Luminus/Citizen
 Driver:LiFud/PF>0.9
 Life span:30000 hours

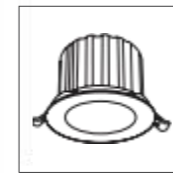

灯具类型: 射灯 -KPECLRS35W
 电压: 220-240V/50Hz
 功率: 35W
 色温: 2700K/3000K/4000K/5000K
 光通量: 3300lm
 显色指数: Ra>90
 光束角: 15度 /24度
 颜色: 白+黑+灰
 材质: 铝材质
 尺寸: 160*105mm
 开孔: 150mm
 光源: 科锐 / 朗明纳斯 / 西铁城
 电源: 莱福德电源 /PF>0.9
 光源寿命: 30000 小时



光学配件 / OPTICAL ACCESSORIES



可选 / 不必要 / OPTIONAL / NOT NECESSARY
 KPE01A 柔光镜 soft lens
 KPE02B 蜂窝网 honeycomb
 KPE03C 拉伸镜 striation glass
 KPE04D 清玻片 Clear glass

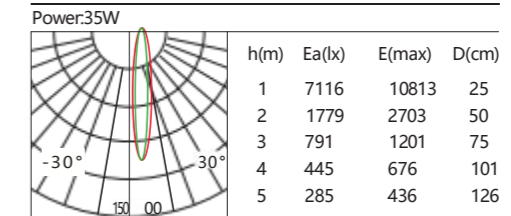

Beam Angle 15° Luminous flux(lm):1274 I_{max}(cd):10818



LED
DINING LIGHT
Mountain Series

LED Dining Light—Mountain Series
LED 餐吊灯—高山系列



KPEDLMS7W300

KPEDLMS10W600

KPEDLMS10W300



KPEDLMS12W600

KPEDLMS12W300

KPEDLMS15W600



Type:Spotlight-KPEDLMS7W300
 Voltage:220-240V/50Hz
 Power:7W
 Color Temperature: 2700K/3000K/4000K/5000K
 Luminous Flux:600lm
 CRI:Ra>90
 Beam Angle:15° /24° /36°
 Color:White/Black/Golden/Silver
 Material:Aluminium
 Size:40*300mm
 Adapter:2/3/4-Circuit/Surface Mounted
 Chips:Cree/Luminus/Citizen
 Driver:Isolated/PF>0.9
 Life span:30000 hours

灯具类型: 射灯 -KPEDLMS7W300
 电压: 220-240V/50Hz
 功率: 7W
 色温: 2700K/3000K/4000K/5000K
 光通量: 600lm
 显色指数: Ra>90
 光束角: 15度 /24度 /36度
 颜色: 白 / 黑 / 金 / 银
 材质: 铝材
 尺寸: 40*300mm
 适配器: 2/3/4 线导轨式 / 吸顶式
 光源: 科锐 / 朗明纳斯 / 西铁城
 电源: 隔离电源 / PF>0.9
 光源寿命: 30000 小时

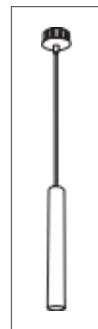

光学配件 / OPTICAL ACCESSORIES

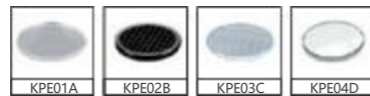

可选 / 不必要 / OPTIONAL / NOT NECESSARY
 KPE01A 柔光镜 soft lens
 KPE02B 蜂窝网 honeycomb
 KPE03C 拉伸镜 striation glass
 KPE04D 清玻片 Clear glass

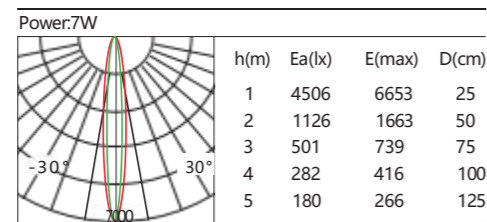

Beam Angle 15° Luminous flux(lm):755 I_{max}(cd):6653



Type:Spotlight-KPEDLMS10W600
 Voltage:220-240V/50Hz
 Power:10W
 Color Temperature: 2700K/3000K/4000K/5000K
 Luminous Flux:900lm
 CRI:Ra>90
 Beam Angle:15° /24° /36°
 Color:White/Black/Golden/Silver
 Material:Aluminium
 Size:40*600mm
 Adapter:2/3/4-Circuit/Surface Mounted
 Chips:Cree/Luminus/Citizen
 Driver:Isolated/PF>0.9
 Life span:30000 hours

灯具类型: 射灯 -KPEDLMS10W600
 电压: 220-240V/50Hz
 功率: 10W
 色温: 2700K/3000K/4000K/5000K
 光通量: 900lm
 显色指数: Ra>90
 光束角: 15度 /24度 /36度
 颜色: 白 / 黑 / 金 / 银
 材质: 铝材
 尺寸: 40*600mm
 适配器: 2/3/4 线导轨式 / 吸顶式
 光源: 科锐 / 朗明纳斯 / 西铁城
 电源: 隔离电源 / PF>0.9
 光源寿命: 30000 小时

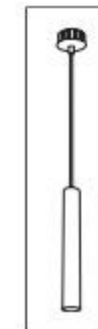

光学配件 / OPTICAL ACCESSORIES



可选 / 不必要 / OPTIONAL / NOT NECESSARY
 KPE01A 柔光镜 soft lens
 KPE02B 蜂窝网 honeycomb
 KPE03C 拉伸镜 striation glass
 KPE04D 清玻片 Clear glass

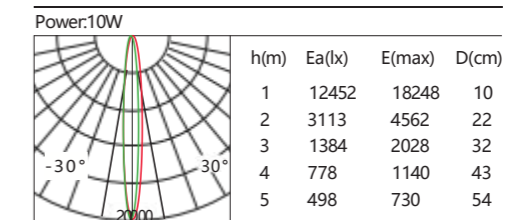

Beam Angle 15° Luminous flux(lm):415 I_{max}(cd):18248



Type:Spotlight-KPEDLMS10W300
 Voltage:220-240V/50Hz
 Power:10W
 Color Temperature: 2700K/3000K/4000K/5000K
 Luminous Flux:900lm
 CRI:Ra>90
 Beam Angle:15° /24° /36°
 Color:White/Black/Golden/Silver
 Material:Aluminium
 Size:50*300mm
 Adapter:2/3/4-Circuit/Surface Mounted
 Chips:Cree/Luminus/Citizen
 Driver:Isolated/PF>0.9
 Life span:30000 hours

灯具类型: 射灯 -KPEDLMS10W300
 电压: 220-240V/50Hz
 功率: 10W
 色温: 2700K/3000K/4000K/5000K
 光通量: 900lm
 显色指数: Ra>90
 光束角: 15度 /24度 /36度
 颜色: 白 / 黑 / 金 / 银
 材质: 铝材
 尺寸: 50*300mm
 适配器: 2/3/4 线导轨式 / 吸顶式
 光源: 科锐 / 朗明纳斯 / 西铁城
 电源: 隔离电源 /PF>0.9
 光源寿命: 30000 小时

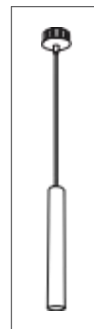

光学配件 / OPTICAL ACCESSORIES

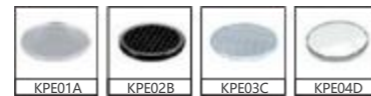

可选 / 不必要 / OPTIONAL / NOT NECESSARY
 KPE01A 柔光镜 soft lens
 KPE02B 蜂窝网 honeycomb
 KPE03C 拉伸镜 striation glass
 KPE04D 清玻片 Clear glass

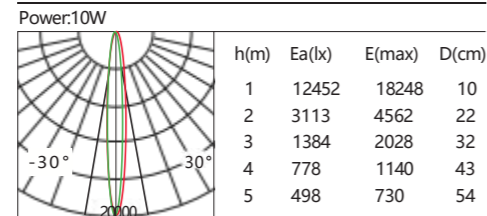

Beam Angle 15° Luminous flux(lm):415 I_{max}(cd):18248



Type:Spotlight-KPEDLMS12W600
 Voltage:220-240V/50Hz
 Power:12W
 Color Temperature: 2700K/3000K/4000K/5000K
 Luminous Flux:1100lm
 CRI:Ra>90
 Beam Angle:15° /24° /36°
 Color:White/Black/Golden/Silver
 Material:Aluminium
 Size:50*600mm
 Adapter:2/3/4-Circuit/Surface Mounted
 Chips:Cree/Luminus/Citizen
 Driver:Isolated/PF>0.9
 Life span:30000 hours

灯具类型: 射灯 -KPEDLMS12W600
 电压: 220-240V/50Hz
 功率: 12W
 色温: 2700K/3000K/4000K/5000K
 光通量: 1100lm
 显色指数: Ra>90
 光束角: 15度 /24度 /36度
 颜色: 白 / 黑 / 金 / 银
 材质: 铝材
 尺寸: 50*600mm
 适配器: 2/3/4 线导轨式 / 吸顶式
 光源: 科锐 / 朗明纳斯 / 西铁城
 电源: 隔离电源 /PF>0.9
 光源寿命: 30000 小时



光学配件 / OPTICAL ACCESSORIES



可选 / 不必要 / OPTIONAL / NOT NECESSARY
 KPE01A 柔光镜 soft lens
 KPE02B 蜂窝网 honeycomb
 KPE03C 拉伸镜 striation glass
 KPE04D 清玻片 Clear glass

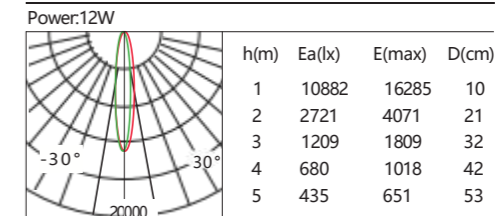

Beam Angle 15° Luminous flux(lm):384 I_{max}(cd):16292



Type:Spotlight-KPEDLMS12W300
 Voltage:220-240V/50Hz
 Power:12W
 Color Temperature: 2700K/3000K/4000K/5000K
 Luminous Flux:1100lm
 CRI:Ra>90
 Beam Angle:15° /24° /36°
 Color:White/Black/Golden/Silver
 Material:Aluminium
 Size:65*300mm
 Adapter:2/3/4-Circuit/Surface Mounted
 Chips:Cree/Luminus/Citizen
 Driver:Isolated/PF>0.9
 Life span:30000 hours

灯具类型: 射灯 -KPEDLMS12W300
 电压: 220-240V/50Hz
 功率: 12W
 色温: 2700K/3000K/4000K/5000K
 光通量: 1100lm
 显色指数: Ra>90
 光束角: 15度 /24度 /36度
 颜色: 白 / 黑 / 金 / 银
 材质: 铝材
 尺寸: 65*300mm
 适配器: 2/3/4 线导轨式 / 吸顶式
 光源: 科锐 / 朗明纳斯 / 西铁城
 电源: 隔离电源 / PF>0.9
 光源寿命: 30000 小时

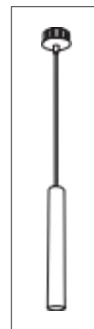

光学配件 / OPTICAL ACCESSORIES



可选 / 不必要 / OPTIONAL / NOT NECESSARY
 KPE01A 柔光镜 soft lens
 KPE02B 蜂窝网 honeycomb
 KPE03C 拉伸镜 striation glass
 KPE04D 清玻片 Clear glass

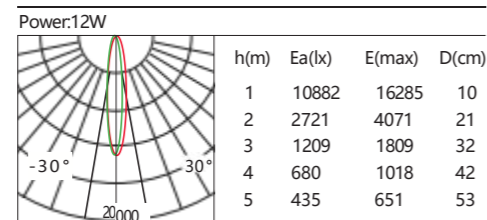

Beam Angle 15° Luminous flux(lm):384 I_{max}(cd):16292



Type:Spotlight-KPEDLMS15W600
 Voltage:220-240V/50Hz
 Power:15W
 Color Temperature: 2700K/3000K/4000K/5000K
 Luminous Flux:1400lm
 CRI:Ra>90
 Beam Angle:15° /24° /36°
 Color:White/Black/Golden/Silver
 Material:Aluminium
 Size:65*600mm
 Adapter:2/3/4-Circuit/Surface Mounted
 Chips:Cree/Luminus/Citizen
 Driver:Isolated/PF>0.9
 Life span:30000 hours

灯具类型: 射灯 -KPEDLMS15W600
 电压: 220-240V/50Hz
 功率: 15W
 色温: 2700K/3000K/4000K/5000K
 光通量: 1400lm
 显色指数: Ra>90
 光束角: 15度 /24度 /36度
 颜色: 白 / 黑 / 金 / 银
 材质: 铝材
 尺寸: 65*600mm
 适配器: 2/3/4 线导轨式 / 吸顶式
 光源: 科锐 / 朗明纳斯 / 西铁城
 电源: 隔离电源 / PF>0.9
 光源寿命: 30000 小时



光学配件 / OPTICAL ACCESSORIES



可选 / 不必要 / OPTIONAL / NOT NECESSARY
 KPE01A 柔光镜 soft lens
 KPE02B 蜂窝网 honeycomb
 KPE03C 拉伸镜 striation glass
 KPE04D 清玻片 Clear glass

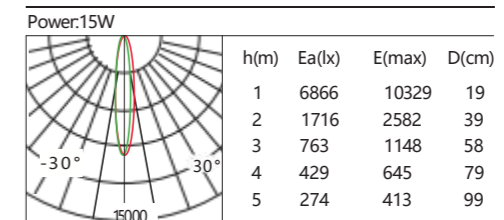

Beam Angle 15° Luminous flux(lm):638 I_{max}(cd):10329



LED T5 TUBE Square Series



Type:0.3MTube-KPET5TSS5W
 Voltage:220-240V/50Hz
 Power:5W
 Color Temperature: 3000K/4000K/6000K
 Luminous Flux:450lm
 CRI:Ra>85
 Beam Angle:120°
 Color:White
 Material:PVC
 Size:308*23*35mm
 Adapter:Surface Mounted
 Chips:Sanan
 Driver:Isolated/PF>0.5
 Life span:30000 hours

灯具类型: 0.3 米灯管 -KPET5TSS5W
 电压: 220-240V/50Hz
 功率: 5W
 色温: 3000K/4000K/6000K
 光通量: 450lm
 显色指数: Ra>85
 光束角: 120 度
 颜色: 白
 材质: PVC
 尺寸: 308*23*35mm
 适配器: 明装式
 光源: 三安
 电源: 隔离电源 /PF>0.5
 光源寿命: 30000 小时



Type:0.6MTube-KPET5TSS10W
 Voltage:220-240V/50Hz
 Power:10W
 Color Temperature: 3000K/4000K/6000K
 Luminous Flux:900lm
 CRI:Ra>85
 Beam Angle:120°
 Color:White
 Material:PVC
 Size:568*23*35mm
 Adapter:Surface Mounted
 Chips:Sanan
 Driver:Isolated/PF>0.5
 Life span:30000 hours

灯具类型: 0.6 米灯管 -KPET5TSS10W
 电压: 220-240V/50Hz
 功率: 10W
 色温: 3000K/4000K/6000K
 光通量: 900lm
 显色指数: Ra>85
 光束角: 120 度
 颜色: 白
 材质: PVC
 尺寸: 568*23*35mm
 适配器: 明装式
 光源: 三安
 电源: 隔离电源 /PF>0.5
 光源寿命: 30000 小时



灯具类型: 0.9 米灯管 -KPET5TSS14W
 电压: 220-240V/50Hz
 功率: 14W
 色温: 3000K/4000K/6000K
 光通量: 1300lm
 显色指数: Ra>85
 光束角: 120 度
 颜色: 白
 材质: PVC
 尺寸: 868*23*35mm
 适配器: 明装式
 光源: 三安
 电源: 隔离电源 /PF>0.5
 光源寿命: 30000 小时

灯具类型: 0.9 米灯管 -KPET5TSS14W
 电压: 220-240V/50Hz
 功率: 14W
 色温: 3000K/4000K/6000K
 光通量: 1300lm
 显色指数: Ra>85
 光束角: 120 度
 颜色: 白
 材质: PVC
 尺寸: 868*23*35mm
 适配器: 明装式
 光源: 三安
 电源: 隔离电源 /PF>0.5
 光源寿命: 30000 小时





Type:1MTube-KPET5TSS18W
 Voltage:220-240V/50Hz
 Power:18W
 Color Temperature: 3000K/4000K/6000K
 Luminous Flux:1650lm
 CRI:Ra>85
 Beam Angle:120°
 Color:White
 Material:PVC
 Size:978*23*35mm
 Adapter:Surface Mounted
 Chips:Sanan
 Driver:Isolated/PF>0.5
 Life span:30000 hours

灯具类型: 1米灯管 -KPET5TSS18W
 电压: 220-240V/50Hz
 功率: 18W
 色温: 3000K/4000K/6000K
 光通量: 1650lm
 显色指数: Ra>85
 光束角: 120度
 颜色: 白
 材质: PVC
 尺寸: 978*23*35mm
 适配器: 明装式
 光源: 三安
 电源: 隔离电源 /PF>0.5
 光源寿命: 30000小时



Type:1.2MTube-KPET5TSS20W
 Voltage:220-240V/50Hz
 Power:20W
 Color Temperature: 3000K/4000K/6000K
 Luminous Flux:1800lm
 CRI:Ra>85
 Beam Angle:120°
 Color:White
 Material:PVC
 Size:1168*23*35mm
 Adapter:Surface Mounted
 Chips:Sanan
 Driver:Isolated/PF>0.5
 Life span:30000 hours

灯具类型: 1.2米灯管 -KPET5TSS20W
 电压: 220-240V/50Hz
 功率: 20W
 色温: 3000K/4000K/6000K
 光通量: 1800lm
 显色指数: Ra>85
 光束角: 120度
 颜色: 白
 材质: PVC
 尺寸: 1168*23*35mm
 适配器: 明装式
 光源: 三安
 电源: 隔离电源 /PF>0.5
 光源寿命: 30000小时

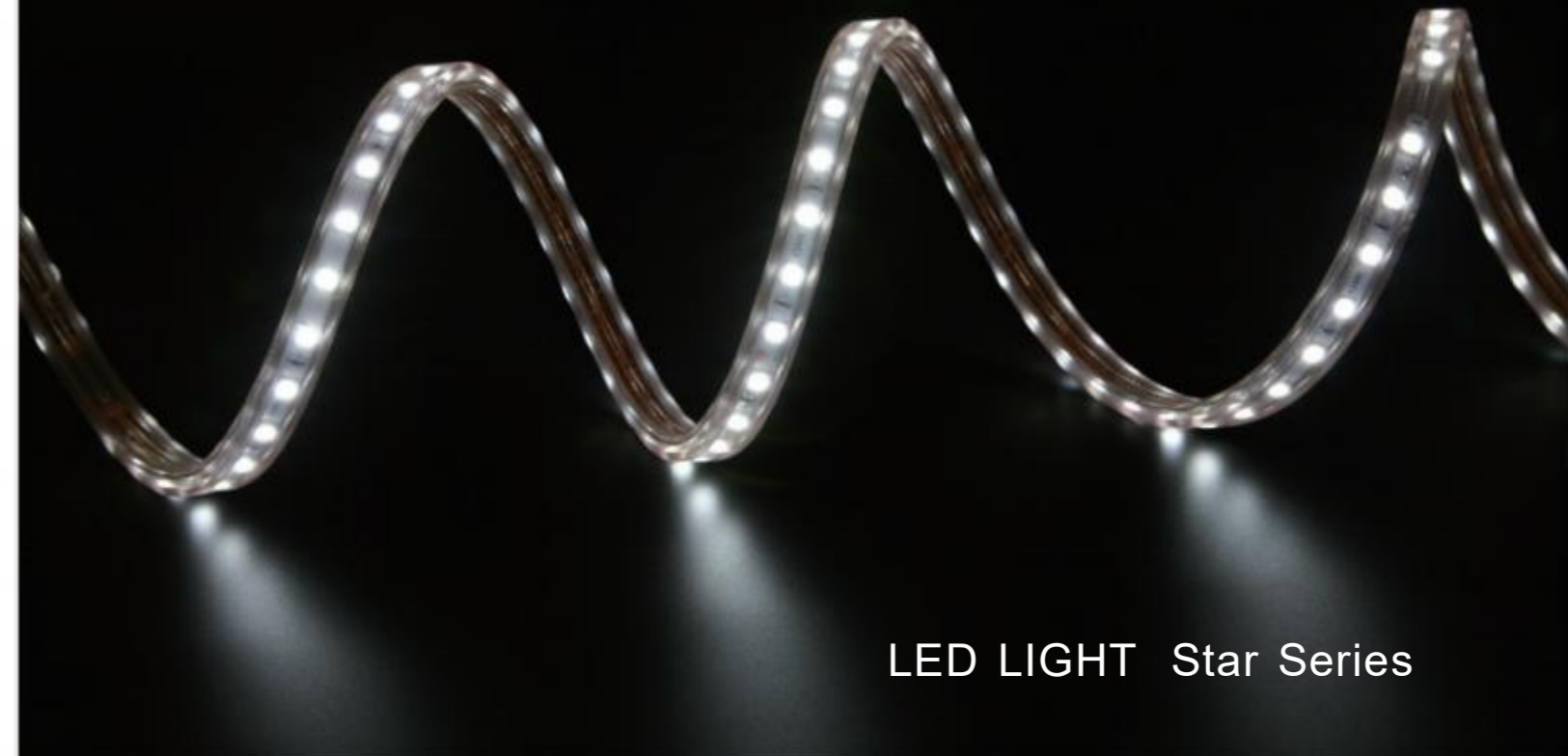

LED LIGHT Star Series



Type:Light5050odd-KPELSS9W
 Voltage:220-240V/50Hz
 Power:9W/M
 Color Temperature: 3000K/4000K/6000K/RED/GREEN/YELLOW/BLUE
 Luminous Flux:700lm/M
 CRI:Ra>80
 Beam Angle:120°
 Color:White
 Material:PC
 Size:15mm
 Adapter:Surface Mounted
 Chips:Sanan
 Driver:Isolated/PF>0.5
 Life span:30000 hours

灯具类型: 5050 单排 -KPELSS9W
 电压: 220-240V/50Hz
 功率: 9W/M
 色温: 3000K/4000K/6000K/红/绿/金黄/冰蓝
 光通量: 700lm/M
 显色指数: Ra>80
 光束角: 120度
 颜色: 白
 材质: PC
 尺寸: 15mm
 适配器: 明装式
 光源: 三安
 电源: 隔离电源 /PF>0.5
 光源寿命: 30000小时



Type:Light2835odd-KPELSS6W
 Voltage:220-240V/50Hz
 Power:6W/M
 Color Temperature: 3000K/4000K/6000K/RED/GREEN/
 YELLOW/BLUE
 Luminous Flux:450lm/M
 CRI:Ra>80
 Beam Angle:120°
 Color:White
 Material:PC
 Size:15mm
 Adapter:Surface Mounted
 Chips:Sanan
 Driver:Isolated/PF>0.5
 Life span:30000 hours

灯具类型: 2835 单排 -KPELSS6W
 电压: 220-240V/50Hz
 功率: 6W/M
 色温: 3000K/4000K/6000K/ 红 / 绿 / 金黄 / 冰蓝
 光通量: 450lm/M
 显色指数: Ra>80
 光束角: 120 度
 颜色: 白
 材质: PC
 尺寸: 15mm
 适配器: 明装式
 光源: 三安
 电源: 隔离电源 /PF>0.5
 光源寿命: 30000 小时



Type:Light2835even-KPELSS9W
 Voltage:220-240V/50Hz
 Power:9W/M
 Color Temperature: 3000K/4000K/6000K/RED/GREEN/
 YELLOW/BLUE
 Luminous Flux:720lm/M
 CRI:Ra>80
 Beam Angle:120°
 Color:White
 Material:PC
 Size:18mm
 Adapter:Surface Mounted
 Chips:Sanan
 Driver:Isolated/PF>0.5
 Life span:30000 hours

灯具类型: 2835 双排 -KPELSS9W
 电压: 220-240V/50Hz
 功率: 9W/M
 色温: 3000K/4000K/6000K/ 红 / 绿 / 金黄 / 冰蓝
 光通量: 720lm/M
 显色指数: Ra>80
 光束角: 120 度
 颜色: 白
 材质: PC
 尺寸: 18mm
 适配器: 明装式
 光源: 三安
 电源: 隔离电源 /PF>0.5
 光源寿命: 30000 小时



LED TRACK Track Series



Type:Track-KPET2WIRES
 Color:White/Black/Grey
 Material:Aluminium
 Size:1M/1.5M/2M*35mm*15mm
 Adapter:Surface Mounted
 Life span:30000 hours

灯具类型: 2 线轨道条 -KPET2WIRES
 颜色: 白 / 黑 / 灰
 材质: 铝型材
 尺寸: 1 米 /1.5 米 /2 米 *35mm*15mm
 适配器: 明装式
 使用寿命: 30000 小时



Type:Track-KPET3WIRES
 Color:White/Black/Grey
 Material:Aluminium
 Size:1M/1.5M/2M*35mm*20mm
 Adapter:Surface Mounted
 Life span:30000 hours

灯具类型: 3 线轨道条 -KPET3WIRES
 颜色: 白 / 黑 / 灰
 材质: 铝型材
 尺寸: 1 米 /1.5 米 /2 米 *35mm*20mm
 适配器: 明装式
 使用寿命: 30000 小时



Type:Track-KPET4WIRES
 Color:White/Black/Grey
 Material:Aluminium
 Size:1M/1.5M/2M*35mm*30mm
 Adapter:Surface Mounted
 Life span:30000 hours

灯具类型: 4 线轨道条 -KPET4WIRES
 颜色: 白 / 黑 / 灰
 材质: 铝型材
 尺寸: 1 米 /1.5 米 /2 米 *35mm*30mm
 适配器: 明装式
 使用寿命: 30000 小时